

Lifestyle and opportunity
@ your doorstep

City of Ryde

Stormwater and Floodplain Management Technical Manual

GLOSSARY

1:5 (V:H)	Slope of 1 vertical to 5 horizontal.
AC	Asphaltic Concrete.
ACRS	Australian Certification Authority for Reinforcing Steel.
Accredited Certifier	Person qualified to issue certificates and operate as a Principal Certifying Authority (PCA) under the Environmental Planning and Assessment Act 1979.
Applicant	Any person/s, company or entity representing the Applicant/Developer for the purpose of carrying out works in association with a Subdivision, Development, Building or Construction works. This may also include Council.
AEP	Annual Exceedance Probability
AR&R (1998)	Australian Rainfall and Run-off (1998).
ARI	Average Recurrence Interval.
AS	Australian Standards published by the Standards Association of Australia and being current at the time of application.
Council	Ryde City Council as represented by its employees.
Engineer or Registered Engineer (NPER)	Person who is a practising Engineer registered on the Institution of Engineers Australia, National Professional Engineers Register (NPER) Engineer in the relevant field of work.
EP&A Act	Environmental Planning and Assessment Act 1979, as amended.
EPA	Environmental Protection Authority.
FRC	Fibre Reinforced Cement
NATA	National Association of Testing Authorities, Australia.
NATA Laboratory	A laboratory accredited by Nata to undertake the specific test referred Registered to in the body of the text.
OH&S	Occupational Health & Safety.
OSD	On-site Stormwater Detention.
PSD	Permissible Site Discharge.
PMF	Probable Maximum Flood
RCP	Reinforced Concrete Pipe.
RHS	Rectangular Hollow Section.
RMS	Roads & Maritime Services, New South Wales (previously known as RTA).
Site	Area of land being developed under the Subdivision or Development Approval.
SQID	Stormwater Quality Improvement Device.
SSR	Site Storage Requirement.
Surveyor	Registered Surveyor.
UCS	Unconfined Compressive Strength.
UPVC	Unplasticised Polyvinyl Chloride compounds (referring to pipe).
VCP	Vitrified Clay Pipe.

WAE Works as Executed Plan.
Works The development of land as described by the Drawings and Specifications (the Documents) as proposed by the Applicant and as cited and approved by Council "For Construction" including all the area of the land being developed.
WSUD Water Sensitive Urban Design.

Table of Contents

STORMWATER DRAINAGE.....	6
1.1 Scope	6
1.2 Property Drainage	6
1.3 Stormwater Discharge from Property	8
1.4 Onsite Stormwater Detention (OSD) Systems	21
1.5 Trunk Drainage Design.....	33
1.6 Drainage for low level properties	34
FLOODING AND OVERLAND FLOW.....	38
2.1 Freeboard requirements	38
2.2 Preparation of a Flood Impact Statement.....	41
2.3 Flood Analysis	45
2.4 Fencing and Landform.....	47
2.5 Piping overland flow	47
ENGINEERING DRAWING AND REPORT REQUIREMENTS.....	48
3.1 Stormwater Drainage Submissions	48
HYDROLOGY	54
4.1 General.....	54
4.2 Design Average Recurrence Intervals (ARI)	55
4.3 Rational Method	56
4.4 Time of Concentration	57
4.5 Rainfall Intensities	58
4.6 Run-off Coefficient.....	58
4.7 Catchment Area	61
HYDRAULICS	62

5.1	Aim	62
5.2	Minor System Criteria	62
5.3	Major System Criteria	62
5.4	Hydraulic Grade Line Analysis	64
5.5	Pit Requirements	66
5.6	Pipe and Culvert Requirements.....	69
5.7	Bridges and Culverts	71
5.8	Overland Flow	71
WATERWAYS		74
6.1	Scope	74
6.2	Aim	74
6.3	General.....	74
6.4	Stability and Runoff Frequency	74
6.5	Riparian Zone.....	74
6.6	Stream Rehabilitation	75
6.7	Riparian Vegetation Management.....	78
SOIL AND WATER MANAGEMENT.....		80
7.1	Scope	80
7.2	Aim	80
7.3	General.....	80
APPENDAGES.....		81

1 STORMWATER DRAINAGE

1.1 Scope

This section of the manual sets out Council's technical requirements in relation to Stormwater and Floodplain Management and is to be read in conjunction with the Council documents;

- DCP Part 7.3 - "*Stormwater and Floodplain Management*", (commonly referred to as "the DCP" in the following document)
- "*Water Sensitive Urban Design Guidelines*".

The following controls apply to the management of stormwater on sites, point of discharge and the manner of discharge particular for the Ryde Council area.

The design of stormwater drainage systems must be generally be undertaken in accordance with the following documents, which are referenced as the "*key documents*" throughout the following section:

- the current edition of Australian Rainfall and Run-off (AR&R), and;
- the latest edition of AS3500.3 National Plumbing and Drainage Code Part 3: Stormwater Drainage.

1.2 Property Drainage

Notwithstanding the minimum requirements of the key documents, the following controls apply to surface drainage systems.

1.2.1 Surface Runoff

Property drainage systems must be designed to reduce the extent and level of ponded water on property, prevent concentrated stormwater runoff entering neighbouring and reduce erosion.

- a) All surface drainage systems must be designed with respect to Section 2.1 of this Technical Manual in regards to overland flow.
- b) All runoff from impervious areas is to be collected,
- c) Runoff entering the site from upstream properties must not be obstructed, nor are they to be concentrated and diverted into neighbouring properties.
- d) Runoff from landscaped areas is to be collected and drained wherever works involve the regrading or alteration to the landform, such to concentrate stormwater runoff and where any long term ponding may occur.
- e) Stormwater runoff from swimming pools is to be taken as fully impervious. Timber decks and similar materials are to be taken as 25% impervious,

1.2.2 Roof Water Runoff

The following controls apply to roof drainage systems;

- a) Roof water drainage systems shall be designed with consideration to the full range of storm events up to the 100yr ARI storm event.
- b) The size of eaves gutters and number of downpipes for residential developments are to be designed to ensure no overflows for storms up to the 20yr ARI storm event. Figure 1-1 shows the maximum catchment area per downpipe required to ensure the gutter capacity is not exceeded (sourced from Australian Standards). Eaves gutters are to be provided with a minimum fall towards the outlet of 1 in 200.
- c) Box gutters are to be sized to ensure no overflows for storms up to the 100yr ARI storm event, in accordance with the key documents. The minimum slope on box gutters should be 1 in 200.

In situations where a building abuts a higher building and its roof is “flushed in” to the higher wall, for the purpose of determining the discharge from the lower roof – the contributing area shall be taken as: the projected roof area of the lower building, plus one half of the area of the vertical wall abutting.

- d) The minimum effective cross-section of a vertical downpipe, including the nozzle shall be not less than 50% of the effective cross sectional area of the gutter that it drains.

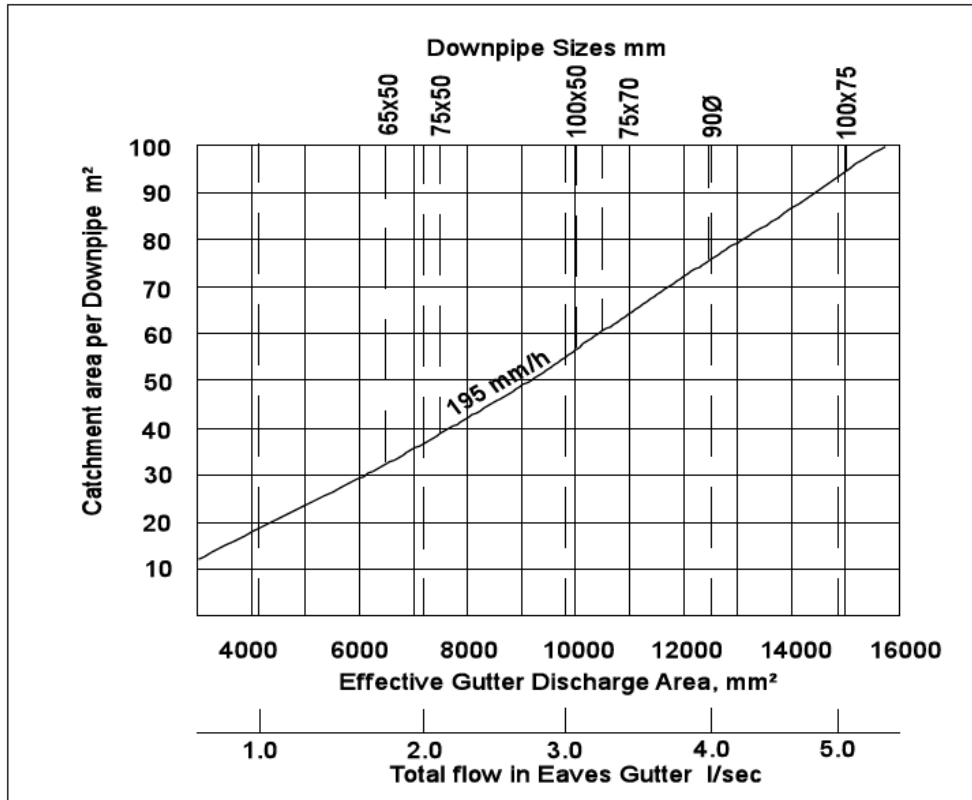

Eaves Gutter and Downpipe Sizing.
From Figure 5.1 in AS 2180 - 1986

Figure 1-1 Eaves Gutter and Downpipe sizing for small developments

1.2.3 Subsoil Drainage

Subsoil drainage shall be provided as part of the stormwater management system to protect structures and mitigate long term surface water ponding. The following controls apply to subsurface drainage systems;

- Subsoil drains must discharge to a surface boundary pit prior to the discharge point so as to minimise the distribution or accrual of sediment in the receiving drainage system.
- In instances where subsoil drainage will affect the groundwater table, the level of drawdown must be contained within the site and not to influence neighbouring properties.
- The subsoil drainage system must be designed to prevent constant discharge of groundwater to the receiving drainage system so as to avoid nuisance surface seepage.

1.2.4 Rainwater Tanks

Rainwater tanks are to be installed in accordance with the manufacturer’s specification and the latest edition of AS3500.3 National Plumbing and Drainage Code Part 3: Stormwater Drainage. Where rainwater tanks are proposed under Exempt and Complying Development the requirements under State Environment and Planning Policy (SEPP) shall apply.

The following requirements apply;

- a) If abutting a wall of the dwelling must be below the eaves line.
- b) Must not be visually obtrusive from the public domain and primary outlooks from adjoining property.
- c) Maximum height of the tank is 1.8 metres above the existing natural ground level where it is installed adjoining the rear or side boundary of a dwelling.
- d) Rainwater tanks must be sealed to prevent mosquitoes breeding in the reservoir.
- e) All tanks/tank stand installations shall be structurally sound and comply with the manufacturer's and/or designer's instructions.
- f) Must be a commercially manufactured tank designed for the use of water supply.
- g) Overflow from the tank must be piped directly to an approved stormwater system.
- h) The external finishes of the tanks shall be painted or coloured to be compatible with the surrounding environment. Alternatively the water tank may be screened behind a permanent physical barrier that serves that purpose.
- i) Taps associated with the tank shall be clearly marked indicating the source of the water and that it is not to be used for Drinking Water.
- j) The installation of the rainwater tank must be undertaken by a licensed plumber.

1.2.5 Regional retarding basins/wetlands

On-line retarding basins should be designed in accordance with Section 5.4 of Council's document "*Water Sensitive Urban Design Guidelines*". The following requirements apply;

- a) Retarding basins shall be designed to visually enhance the landscape form of the site and should incorporate a landscaped wetland. Grass lined, generally trapezoidal basins with low flow pipe systems and little landscaping will not be approved.
- b) Basins/wetlands should be designed as a community passive recreational facility as well as providing an essential flow retarding function.
- c) Where saline soils are identified as a development issue, strategies to minimise the impacts the wetland may have on water tables or movement of saline groundwater must be implemented. This may include, but not be limited to, lining of wetlands or restrictions on cut-fill of the proposed urbanised catchment.
- d) Spillways of basins shall be designed to safely pass extreme storm events without structural failure of the embankment.
- e) Landscape plans must not include placement of deep-rooted trees or shrubs where roots may promote piping or structural failure of engineered embankments, should they be uprooted during major storm events.
- f) The basin design must be subject to a detailed risk assessment, for all events up to and including the PMF, where the downstream floodplain is urbanised. The risk assessment must include an assumption of catastrophic structural failure; i.e. a dam break scenario. Large basins may need to be referred to the Dam Safety Committee for review.

1.3 Stormwater Discharge from Property

The following section defines the procedure in determination of an appropriate point of discharge and the requirements associated with the manner of discharge. The point of discharge from a property is an essential aspect of the drainage system with respect to potential impacts to adjoining property.

Generally there shall be only a single drainage discharge point from a site per allotment. The only exceptions to this are:

- a) When a property is across two sub-catchments (e.g. at the crest of a hill) and the drainage from the site is being directed towards two separate drainage systems and no water is being redirected from one sub-catchment to another.

- b) To disperse the discharge of stormwater from a large site to the public drainage network in order to mitigate or prevent localised flooding effects.
- c) When it is necessary to convey overland flow from other properties to the public road.
- d) The point of stormwater discharge will obviously depend on where the site falls to. To ensure there are no impacts to the downstream infrastructure, the property drainage system should seek to discharge to the public drainage network (whether infrastructure or natural watercourse) wherever possible.

The acceptable point of discharge is subject to where the property falls to and the scope of development proposed. Council's requirements with respect to approved stormwater discharge points are specified in Section 2.3 of the DCP Part 7.3 - "*Stormwater and Floodplain Management*".

The following subsections outline requirements relating to each point of stormwater discharge, where permitted under the DCP.

1.3.1 Discharge to Public Drainage Infrastructure

Public drainage infrastructure refers to engineered channels, gutters, pipes and surface inlets designed to convey stormwater runoff from the greater catchment, commonly referred to as the trunk drainage system.

Should the property under development have access to inground public drainage infrastructure (either inside the property or immediately fronting it) a direct connection to this must be made. As specified in the Council's DCP, larger development on sites located within 30m of inground public drainage infrastructure must extend the public drainage infrastructure to the site frontage, to enable a direct connection to be made.

In all cases other than discharge to the kerb, Council must approve the method of connection by the submission of detailed engineering plans and inspect the works prior to backfill. This is to ensure the works are not detrimental to the condition or operation of the infrastructure.

The following requirements relate to the respective point of discharge to this infrastructure.

Kerb and gutter

- a) To minimise the extent of overland flow in gutters, the maximum discharge to the kerb must not be greater than 30 L/s in the 100yr ARI storm event. This may be achieved by reducing the peak site discharge of the OSD system inside the site however will warrant additional storage.
- b) The peak velocity of water being discharged to the kerb must not exceed 2.0m/s.
- c) The alignment of drainage pipe must not cross the footway at an angle no less than 60° to the kerblines and should be located in front of the property.
- d) For sites having adverse levels or low level footpaths, the drainage line may be extended along the footpath or kerb (whichever has less imposition on services) to discharge for a maximum length of 20 metres beyond the site. The length of drainage line must be minimised where possible.
- e) At the point of connection into the kerb the invert of the pipe must match the invert of the kerb. The kerb is to be restored at the point of connection.
- f) Discharge points to the kerb must use the following galvanised steel box-section equivalent to pipe diameters as follows:
 - 100mm DIA outlet pipe – use 1 x 100mm x 100mm x 6mm thick (w x h x t)
 - 150mm DIA outlet pipe – use 1 x 200mm x 100mm x 6mm thick
 - 225mm DIA outlet pipe – use 2 x 200mm x 100mm x 6mm thick

Where the site discharge pipeline is to extend beyond the site frontage across neighbouring properties, the following requirements apply;

- g) Property drainage lines must not extend for more than 20 metres in the verge and are not permitted to be installed under the carriageway,
- h) The maximum depth from invert of gutter to invert of pipe in the verge area must be no greater than 1.2 metres,
- i) The pipe must cross the footway perpendicular to the street with two 45° bends used to turn the pipe parallel to the kerb line,
- j) An inspection eye should be installed on one of the bends,
- k) A sewer grade PVC pipeline may only be used across the footway where the cover is greater than 300 mm.
- l) The .property owner benefitting from the drainage line must fund and restore any services affected by the works and fully reconstruct any driveway crossover that the works intersect.

Inground Drainage Infrastructure

Where the drainage system is able to discharge directly to the inground drainage public drainage network, connection to the system will be permissible by means of either connection to an existing kerb/ junction pit, constructing a new pit to Council's specifications or where a kerb inlet/ junction pit cannot be readily located, installing an appropriate slope junction.

Where the level of development is significant to warrant extension of the inground drainage infrastructure, Council's drainage system is to be extended using a minimum 375 mm RC pipe with a kerb inlet or junction pit to a point near the boundary of the subject property to allow a direct connection.

The following requirements apply pending on the type of connection outlined above.

Existing Kerb inlet pit

- m) Pipes connected to existing pits shall be cut flush with the internal wall of the pit.
- n) The pipe should enter the pit perpendicular to the pit wall and all damage to the internal wall of the pit around the pipe connection must be fully repaired to Council's satisfaction.

New Kerb Inlet Pit

- o) Where a new stormwater pit is to be constructed over an existing pipeline they shall be cast in-situ concrete,
- p) The works are to be undertaken in accordance with the standard detail Appendix 1 of this Manual.

Slope Junction

- q) The site discharge pipeline must be no greater than 225mm. If the property drainage pipeline is greater than 225 mm DIA the line must be connected to an access / junction pit.
- r) Only one slope connection is permissible from the development to Council's system unless the property straddles two sub-catchments each serviced by a different piped system.
- s) Where possible, only the top of the pipe is to be cut to facilitate water inflow and/or access for maintenance. The remainder of the pipe is to be left undisturbed. Any reinforcement exposed is to be treated to prevent concrete cancer to Council's satisfaction.
- t) A cleaning eye or pit must be installed immediately upstream of the connection point to facilitate cleaning in the event of a blockage.
- u) The connection must be made with a collar secured with epoxy adhesive to Council's pipeline to allow an inspection to be made of the interior of the main pipeline. See Appendage 1 in Section 8 for detail.

The design and construction of pits and pipes shall be in accordance with the hydraulic requirements listed in Section 5 - HYDRAULICS of this Manual.

1.3.2 Discharge to a Public Park or Reserve

The uncontrolled discharge of urban stormwater into public parks and reserves can cause significant bushland degradation. The increased volume of water and velocities of water entering these areas compared to natural conditions promotes the formation of unnatural drainage lines, weed invasion and accelerated erosion and sedimentation. It is therefore preferable that properties falling to a public reserve or park drain to public drainage infrastructure in the reserve where possible.

Unfortunately it is not possible to formalise a drainage easement across land zoned as public open space. In order to discharge to public drainage infrastructure in a public park or reserve, Council will be required to extend the infrastructure to the site, at the cost of the property owner. The infrastructure in the reserve/ public park will be retained under the care and ownership of Council.

An application may be made to Council to connect to a Council drainage system within the land. This application will be assessed by Councils Public Open Space and Works departments to determine the suitability of the proposal and the cost estimate for the extension of the public drainage infrastructure to the boundary of the property. An application form for this procedure is available from Council and must be accompanied by a non-refundable application fee, as detailed with Council's Management Plan.

A drainage analysis of the system being connected to must be undertaken to show that the downstream receiving system has sufficient capacity to cater for the additional flows generated by the proposed development. It will be at Council's discretion to determine the length, route and discharge point of any drainage system requested.

1.3.3 Discharge to a natural water course or channel

The uncontrolled discharge of urban stormwater into natural water courses and channels can cause a number of ecological and environmental issues, including reducing aquatic and riparian habitat, promoting the formation of unnatural drainage lines, weed invasion and accelerated erosion and sedimentation. Similarly any alterations of existing systems can also cause many ecological and environmental issues.

Conventional techniques such as concreting and piping of waterways impact on downstream watercourses by increasing the quantities and velocities of stormwater, resulting in creek bed and bank erosion, and flooding. When discharging stormwater to a channel or natural water course it is imperative that the existing system is maintained or restored to its natural state.

Discharge to a suitable natural watercourse, creek or channel may be allowed subject to approval by Council. The watercourse is to be protected against erosion at the point of discharge. In this regard an outfall apron or energy dissipation structure is to be provided in accordance with this Section. Stabilising a small length of the watercourse in the vicinity of the outlet is not appropriate as it can cause problems of erosion upstream and downstream of the stabilised section.

Only a single discharge point to the watercourse from the development will be permissible.

The piping, covering or alteration of a natural watercourse will not be approved by Council except in limited cases (see Section 2 - FLOODING AND OVERLAND FLOW). Instead, existing natural watercourses must be retained, along with any native vegetation within the riparian zone. In addition, the rehabilitation of degraded, piped or channelled watercourses to a more natural state will be encouraged and supported wherever possible.

Where stormwater flows into or through bushland reserves adjacent to natural watercourses/creeks forming unnatural drainage lines, it should be channelled, piped or consolidated into an existing watercourse to reduce the impacts on the surrounding bushland. Combinations of these systems may

also be acceptable. Open channels can be rock-lined with material similar to that found in the local area to reduce erosion and to mimic a natural system with riffle zones and stilling ponds.

Dissipators or small stilling basins should be used where piped stormwater enters bushland or watercourses to reduce stormwater velocity and erosion.

Outflow aprons shall be designed and constructed for all headwall outlets, regardless of the type of development to ensure downstream and receiving properties are not adversely affected by the concentration of stormwater flows.

Outflow aprons are normally constructed of rip-rap or concrete with embedded rip-rap. Pipes with a diameter less than 300 mm shall be designed in accordance with the following detail:

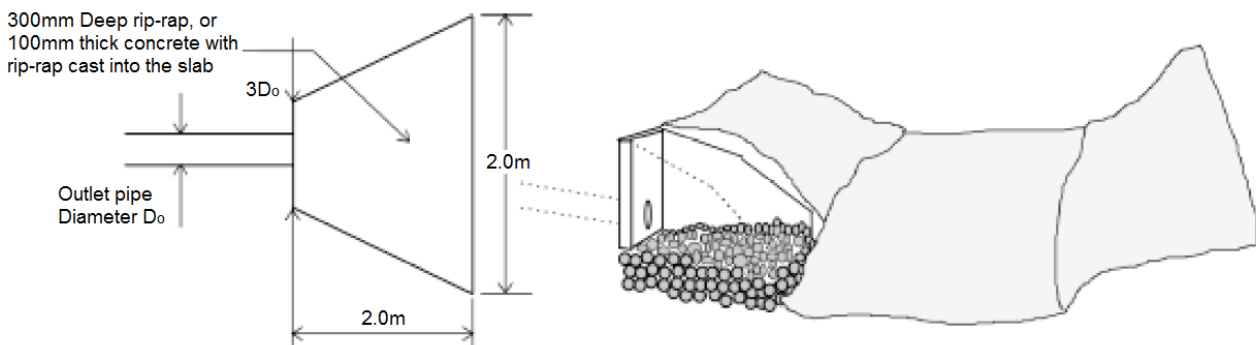

Figure 1-2 Outflow apron.

Pipes 300 mm DIA and larger are to be designed in accordance with NSW Department of Housing publication “Soil and Construction” or Landcom’s “Managing Urban Stormwater – Soil and Conservation – Volume 1” 4th Edition 2004 (Blue Book). Pipelines larger than 375 mm DIA with an outlet in a location that will result in scour must have the outlet angled at 30 degrees to the direction of the flow within the watercourse or channel. The median size of rip rap protection to be used in the outflow apron shall also be sized in accordance with the Blue book.

When discharging to an existing creek or watercourse the end of the pipe should be no closer than 2.0 metres from the existing creek bank. The end of the apron should be the same level as the bed of the watercourse. Energy dissipators reduce water velocity by directing the water stream into obstructions placed in the flow path and/or by invoking a hydraulic jump. Energy dissipators are to be designed to reduce velocities to below 2.0 m/s during the design storm. Energy dissipators shall be provided to outlet structures at natural water courses and open channels in accordance with Section 8 of the RMS document, “RTA Road Design Guide”, the Blue book or similarly recognised publications where the permissible velocities in Table 1.1 below are exceeded.

Figure 1-3 shows four examples of energy dissipators to treat stormwater before draining to a watercourse, channel or creek.

Channel Gradient (%)	Permissible Velocity (m/s)
1	2.1
2	1.9
3	1.8
4	1.7
5	1.6
6	1.6
8	1.5
10	1.5
15	1.4
20	1.3

Table 1.1 Permissible velocities for vegetated channels.

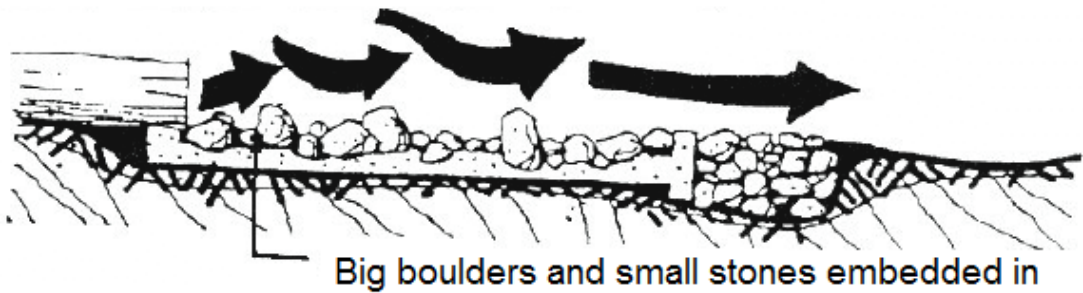

Big boulders and small stones embedded in

HORIZONTAL ROUGHNESS ENERGY DISSIPATORS

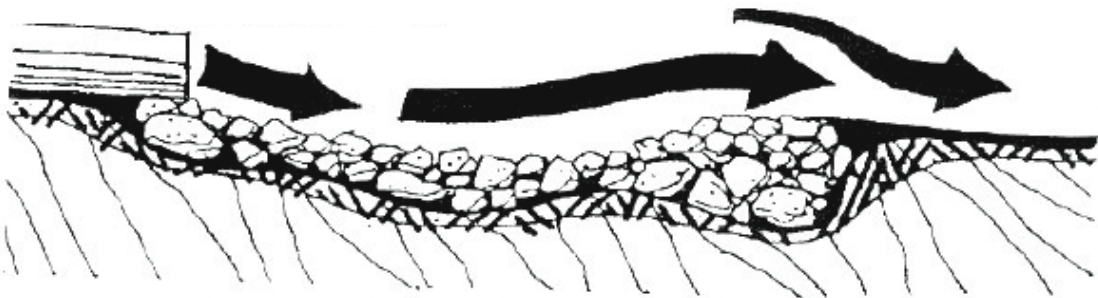

RIP-RAP ENERGY DISSIPATOR

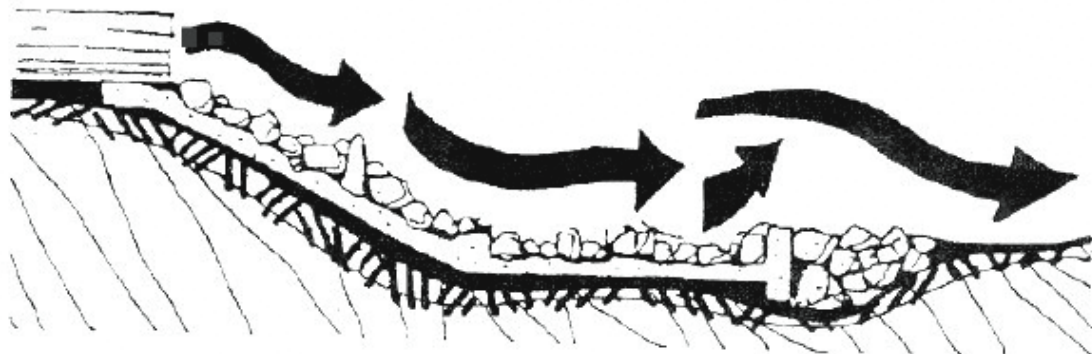

FORCED JUMP ENERGY DISSIPATOR

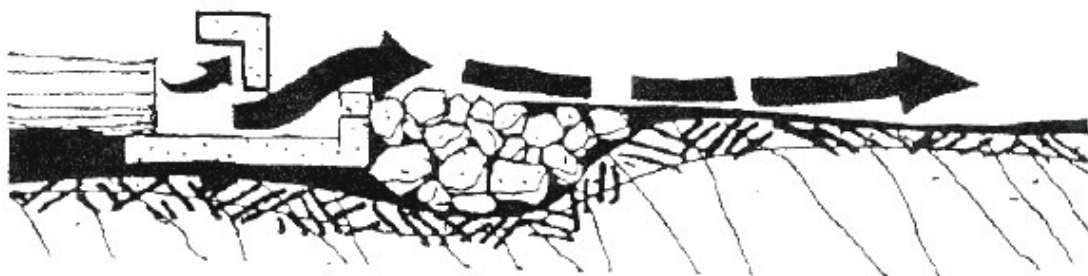

IMPACT ENERGY DISSIPATOR

Figure 1-3: Energy dissipators

1.3.4 Discharge via a new or existing Drainage Easement/ Reserve

Where a property is to discharge via a new or established private drainage easement, the following requirements apply. Refer to Section 1.6 (Drainage for low level properties) regarding the acquisition of a drainage easement.

- a) Where the property drainage system will discharge via an existing drainage easement or inter-allotment drainage easement, evidence that the property benefits over the easement must be submitted with the application for the works.
- b) Where a new easement is to be created, Council may consider issuing a deferred consent after consideration of the feasibility of the easement, scope of works and point of discharge.
- c) Collected runoff from the development site shall be kept separate from the drainage system of the property through which the easement is passing. In some cases this may require the piped system to be of a capacity to accommodate stormwater runoff from the 100yr ARI storm event where a suitable overland flow route is not available.
- d) The design and construction of the drainage reserve or easement shall be in accordance with the hydraulic and discharge requirements listed in this document.
- e) The minimum width of new drainage easements should be in accordance with Table 1.2.

Drainage	Easement Width (m)
<u>Inter-allotment Drainage</u>	
Pipes < 150mm	1.0
Pipes up to 300mm	1.5
Pipes up to 900mm	2.5
Pipes > 900mm	Width required for maintenance, but not less than width of conduit + 1.5m and not less than 2.5m.
<u>Public Drainage Infrastructure</u>	
Pipes <=1350mm	3.0
Pipes > 1350mm	Width of the system plus 2.0m

Table 1.2: Minimum Width of Easements

- f) Where the pipeline serves more than three (3) lots, a hydraulic grade line analysis will be required with the design submission to ensure lots are not affected by surcharge.
- g) Minimum cover for pipelines within allotments shall be 300mm, apart from footway crossings to kerbs with galvanized steel Rectangular Hollow Sections (RHS) as specified in Section 1.3.1 (Discharge to Public Drainage Infrastructure).

- h) The desirable minimum pipe grade shall be 1.0% and pipes shall be designed to accept concentrated drainage from OSD systems or the concentrated drainage from buildings and paved areas.
- i) The minimum pipe sizes for inter-allotment drainage are as specified below in Table 1.3.

Number of Allotments	Minimum Pipe Size (mm)
1-4 lots	150
5-8 lots	225
9-15 lots	300
16-25 lots	375

Table 1.3 Minimum pipe sizes for inter-allotment drainage.

- j) Each allotment draining to the inter-allotment drainage line shall have direct access to the pipe line via a junction pit located on their lot.
- k) Inter-allotment drainage pits shall also be located at changes of grade, pipe size or direction and spaced no further than 75m apart.

1.3.5 Discharge to an On-site Dispersal/ Absorption System

Such systems involve the diversion of stormwater runoff to a pit or trench set below ground, to allow the stormwater runoff to permeate into the soil or, for an onsite dispersal system, percolate up and disperse as sheet flow downstream of the discharge point. Whilst these systems provide some water quality benefits and assist in recharging groundwater tables, they have limited capacity to dispose of large quantities of stormwater runoff. This is due to the typically low permeability of soils in the Ryde area. Figure 1-5 shows a typical absorption system layout.

On-site dispersal systems are designed to mimic natural stormwater runoff by dispersing stormwater runoff over wide areas. They are generally utilised where property falls to a natural reserve/ parkland and there is no risk of property damage due to stormwater inundation.

First flush infiltration systems are small gravel filled trenches wrapped in a geofabric membrane with a slotted pipe in the centre of the gravel bed that will disperse the first part of the runoff from a site into the ground. The “first flush” runoff from small catchment areas generally has the highest nutrient loading and this type of system will take this small volume off line and allow the main part of the storm flow to pass on to the downstream drainage system.

The following controls apply to the design of absorption/ onsite dispersal drainage systems where permitted under the DCP;

- a) The property must not be located within any areas identified by Council as containing soil types that are predominantly not conducive to the dispersion of stormwater, areas likely to induce landslip or areas where there is a clearly identified soil salinity problem. The applicant should liaise with Council as to whether their property is so affected before further proceeding with any detailed drainage design.

- b) The on-site absorption system will not have an adverse impact upon adjoining and/or downstream properties by the direction or concentration of stormwater on those properties.
- c) There is an area downslope of the dwelling at least equal to the impervious area draining to it which to construct the absorption trench.
- d) The infiltration trench/ pit is to be designed with a capacity in accordance to Council's absorption trench calculation sheet in Appendix 2.
- e) On-site absorption structures are to be located a minimum 5 metres from the downstream property boundary and a minimum of 3.0 metres from buildings. Where the property adjoins bushland the absorption trench may be constructed no less than 2 metres from the boundary adjoining the bushland and run parallel with the contours.
- f) The system should not be placed under any paved surfaces and must be at least 1.0 metre from pavements subject to vehicular traffic.
- g) A debris/silt collection pit shall be constructed immediately upstream of the underground system, a capped observation riser installed over the underground system and the area downstream is to be landscaped in a manner that will ensure a reduction of sub-soil flows into the adjoining property.
- h) The system should be designed to allow the majority of the sediment to be collected at the inlet to the system and have a cleaning eye at the opposite end to allow flushing of any sediment and or debris back to the cleaning sump if necessary.
- i) Where a high water table is encountered and a gravel filled trench design is proposed, the base of the trench should be at least 500mm above the water table to accommodate ground water table fluctuations.
- j) When an absorption/ onsite disposal system has been approved, no further development will be permitted on the site without a further stormwater management study demonstrating that the system is able to handle the additional runoff.
- k) A positive covenant is to be placed on the Property Title to ensure that the system is adequately maintained according to the approved maintenance schedule. A Restriction as to User is to be placed on the Property Title to ensure that no additional impervious areas are created on the property. The authority to vary the Restriction is to be City of Ryde.
- l) Where an absorption system is to be the primary means of stormwater discharge for a property or the absorption system is located on land identified being prone to slope instability, the stormwater management plan must include a report by a geotechnical engineer providing the following details:
 - An assessment of the infiltration soil profile,
 - Demonstrate that the proposal will not have an adverse impact on adjoining properties by the direction or concentration of stormwater on those properties,
 - Consider antecedent moisture conditions and performance over a variety of rainfall events,
 - Depth to rock strata,
 - Depth to the water table,
 - Measured infiltration rate (in litres/square metres/second),
 - Infiltration rate that can be maintained in the long term,
 - Minimum distance any infiltration system should be located clear of property boundaries,
 - Whether the use of infiltration is likely to cause seepage problems to the proposed structure or to any adjoining properties.

Figure 1-4 on the following page shows an example of a first flush infiltration system suitable for single residential developments.

Notwithstanding the above points, the following requirements apply to the design of onsite dispersal systems (level spreaders):

- m) The provision of an on-site stormwater detention system to limit discharge flow rates must be provided regardless of site coverage. The onsite detention system must comply with Council's simplified design requirements.

- n) The onsite dispersal system is to be located as far as possible from the downstream boundary.

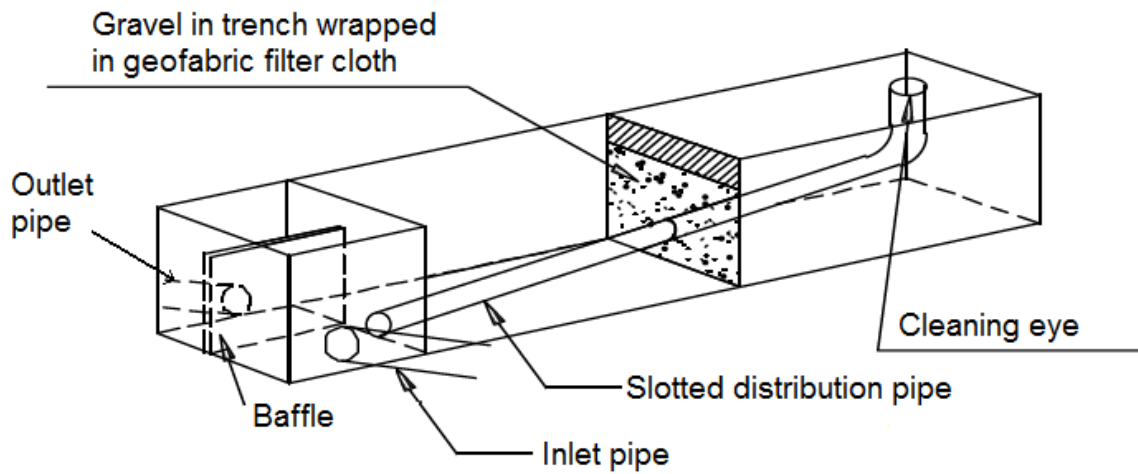

PERSPECTIVE

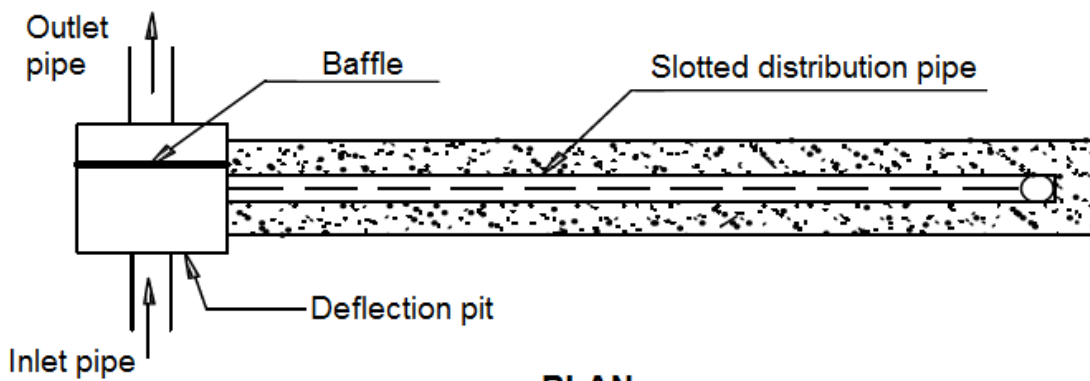

PLAN

(Topsoil removed for clarity)

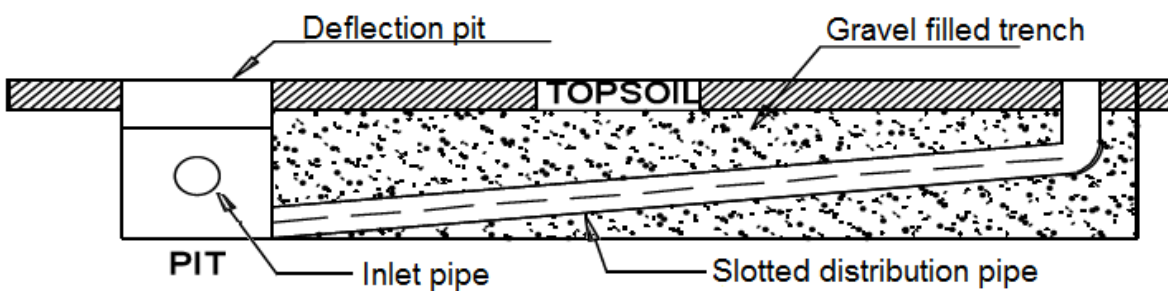

ELEVATION

Figure 1-4: Detail of small first flush infiltration system suitable for single residential developments

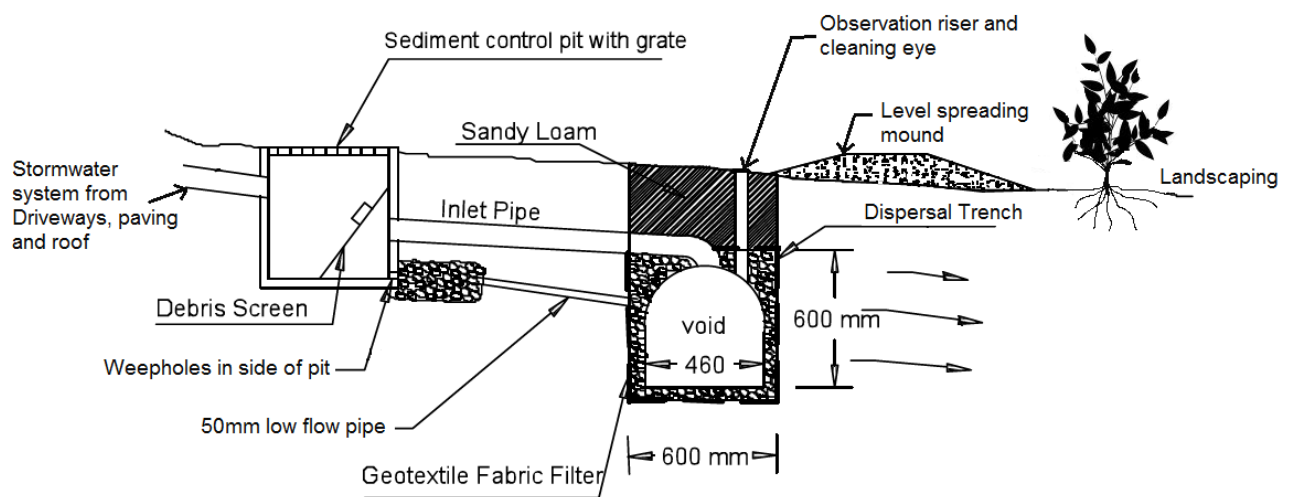
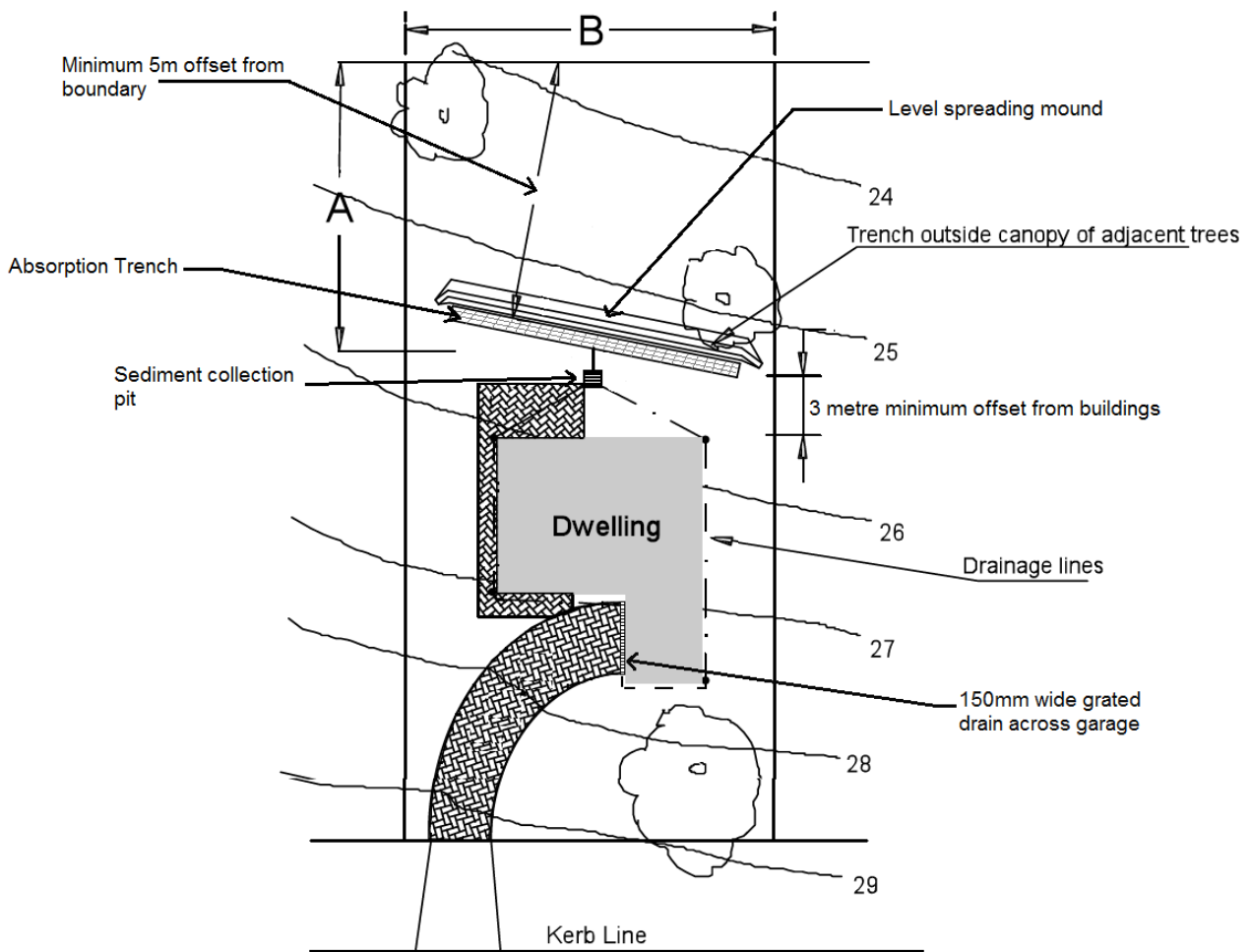

Figure 1-5: Typical Absorption System layout

1.3.6 Discharge to a Charged/ Siphonic System

The following controls apply to the design of charged/ siphonic systems where permitted under the DCP.

- a) All roof gutters and downpipes must be sized to accommodate stormwater runoff from roof areas resulting from the 100yr ARI storm event.
- b) The point of discharge must drain to the same catchment as the site and must not exacerbate flooding issues which would otherwise be unaffected had the site drained via an easement.
- c) There must be a minimum difference in height between the roof gutter and the discharge pit at the property boundary of 1.8 metres. This height may be reduced where a detailed HGL analysis is provided demonstrating the system can adequately operate.
- d) The system must discharge to a boundary junction pit, prior to discharge to the public drainage infrastructure.
- e) Charged lines are not permitted outside the property boundary.
- f) All charged lines must be of pressure grade and joints to be solvent welded.
- g) A clean out pit must be provided at the sump in the system.
- h) Gutter guards must be installed on all gutters to minimise debris entering the system.
- i) Normal On-site Stormwater Detention requirements will still apply.
- j) A Positive Covenant will be required to be placed on the title of the property to inform owners of their responsibility in maintaining the system.

1.3.7 Discharge to a Pump/ Sump System

The following controls apply to pump/ sump drainage systems where permitted under the DCP.

- a) Wet wells shall be designed and constructed in accordance with section 9.3 of AS 3500.3. with the exception that the well shall have the capacity to store the total runoff from the area draining to it during a 100yr - 3 hour ARI event.
- b) The pumps shall be dual submersible pumps and shall be sized and constructed in accordance with section 9.4 of AS 3500.3.
- c) Direct connection of a pump's rising main directly to the kerb is not permitted.
- d) The pumped water must be treated prior to discharge to remove any pollutants.
- e) A Positive Covenant will be required to be placed on the title of the property to inform owners of their responsibility in maintaining the system and to indemnify Council from any claims for damages arising from failure of the pump system.
- f) Full details of the holding tank capacity, pump type, pump curves detailing pump rate vs head, the discharge rate, the delivery line size and head against which the pump must operate must be submitted to Council for approval by Council.

1.3.8 Discharge to an Existing Property Drainage System

Notwithstanding Council's DCP requirements concerning the point of discharge which are to be held, the utilisation of an existing property drainage system must satisfy the following requirements.

- a) The proposed development will not impact on the operation of the existing system (i.e. remove a surface inlet pit or encroach into an OSD system reducing the volume provided),
- b) The hydraulic function of the existing system is unchanged (i.e. the head to discharge remains the same),
- c) The existing stormwater management system has sufficient capacity to cater for the additional runoff from the proposed development up to the 100 year ARI storm event, and
- d) The modifications to the existing system required do not consequently have adverse stormwater impacts upon adjacent or downstream properties.

This will generally require a report prepared by a suitably qualified and experienced engineer, of the existing stormwater management system and its capacity to handle the total (existing and proposed development) runoff from storm events up to the 100yr ARI storm event.

In the case of connecting to an existing on-site absorption system the design is to be accompanied with a report by a geotechnical engineer attesting to the absorption capacity of the system (including any necessary information such as an assessment of the infiltration of the soil profile, consideration of antecedent moisture conditions and performance over a variety of rainfall events) and demonstrating that the proposal will not have an adverse impact upon adjoining and/or downstream properties by the direction or concentration of stormwater on those properties.

The location of the existing stormwater drainage system must be shown on the drainage plans to be submitted in conjunction with the development application.

1.4 Onsite Stormwater Detention (OSD) Systems

An onsite detention (OSD) system seeks to mitigate the increasing rate of stormwater runoff generated by ongoing development in the City of Ryde catchment area.

OSD systems are designed to counteract the effect of each development within a catchment by restricting the rate of stormwater runoff discharged during large storm events. This restricted discharge rate requires a “buffer” storage tank/ basin to detain stormwater before slowly releasing it to the public drainage system. Typical OSD systems are shown in Figure 1-6 and Figure 1-7.

Refer to Section 2.4 (*Community Stormwater Management*) of the DCP - Part 7.3 (*Stormwater and Floodplain Management*) in relation as to when onsite detention is required in development.

1.4.1 Exemption from having to provide an OSD system.

Provision of an OSD system may be waived where:

- a) The site is within the designated **possible** exclusion zone (marked on Council’s mapping system) along the Parramatta and Lane Cove River foreshore subject to there being no known drainage problems in downstream properties.
- b) The applicant can demonstrate to Council’s satisfaction that if the total catchment containing the site were developed to its full potential, stormwater detention on the subject site would not be of benefit in reducing adverse flooding impacts on downstream roads, properties and open watercourses. This may be the case at the lower end of major catchments.
- c) The downstream public drainage network has been upgraded to cater for the storm flows up to 100yr ARI being directed to it.
- d) It is demonstrated that the property is subject to significant inundation (say over 50% inundation of the site due to a 100yr ARI storm event) or that it is impractical to provide an OSD storage facility out of or above this flow when the site is partially inundated OR OSD will not be required where the site of the development is located within a Council established 1 in 100 year ARI floodplain and that it can be demonstrated that lesser storm events will also flood the site. Otherwise it will be necessary to provide OSD to control the runoff for the minor storm events.
- e) The implementation of OSD on the site cannot be achieved without adverse outcomes, in terms of planning, impracticality and amenity to occupants, upon consideration of all feasible options.

Exemption from OSD in each case is required to be confirmed by Council.

1.4.2 General OSD Design Requirements

The following general requirements apply in the design of OSD systems.

- a) The OSD system should be located prior to the point of discharge, generally in the lowest point of the site and located in a common area to facilitate access. This can possibly include a car park, open space area or even roof top areas where no underground storage is possible.
- b) As much as possible of the site area is to drain through to the OSD system(s). A portion of the impervious area may discharge directly to Council's system if it cannot be drained to the storage facility, provided the PSD is reduced and SRR increased to compensate for the smaller catchment.
- c) The maximum desirable extent of impervious surfaces bypassing the OSD system is 25% of the total impervious site area.
- d) Where it is proposed for the site to discharge to the kerb and gutter, the PSD shall be restricted to 30L/s.
- e) A positive covenant must be executed and registered against the title of the lots containing OSD systems to require maintenance of the system. This positive covenant must be on any linen plans for subdivision of the development. If no subdivision is proposed, the covenant shall be prepared prior to finalisation of the development.

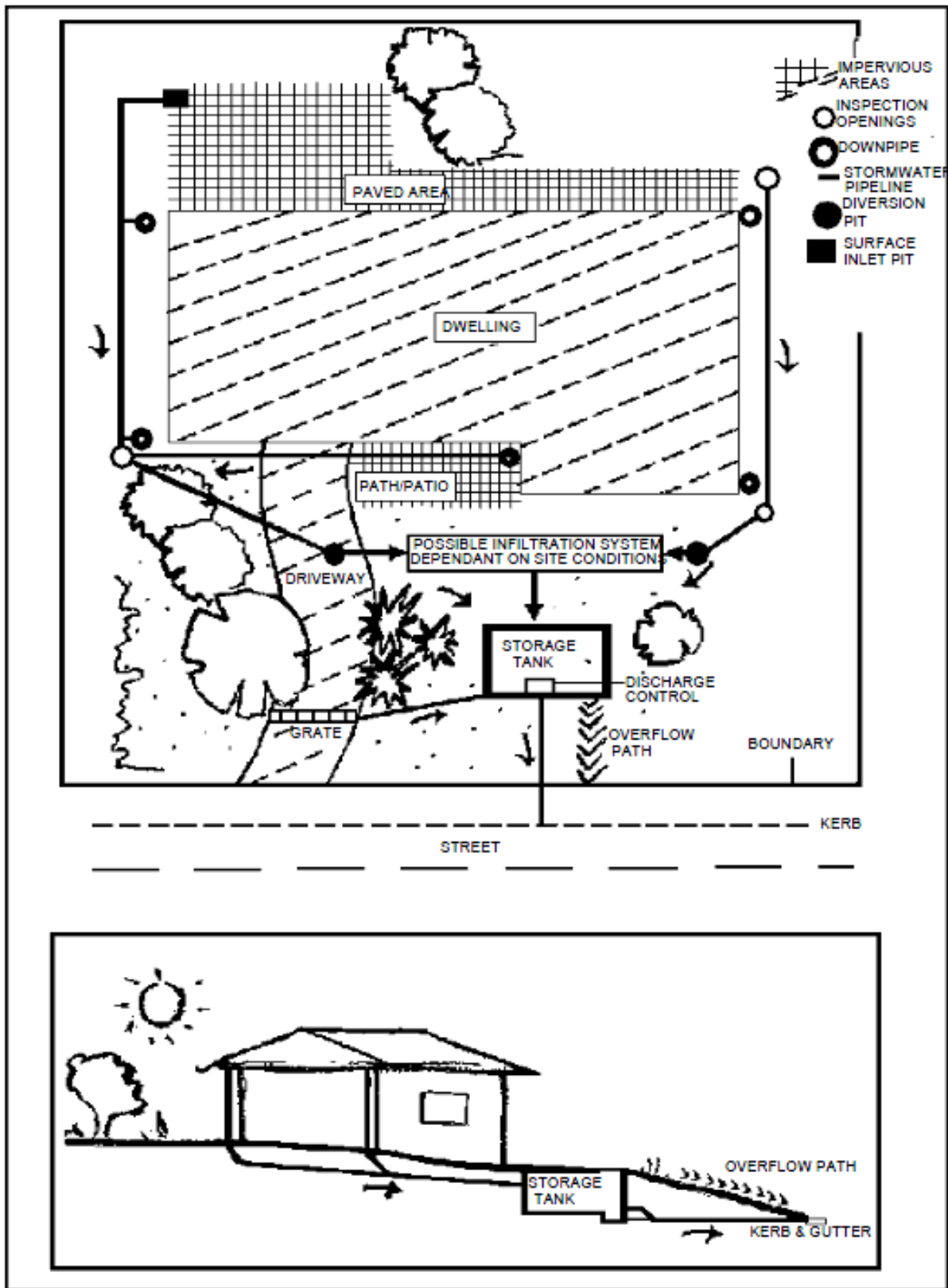

Figure 1-6 : Simplified Below Ground Storage System

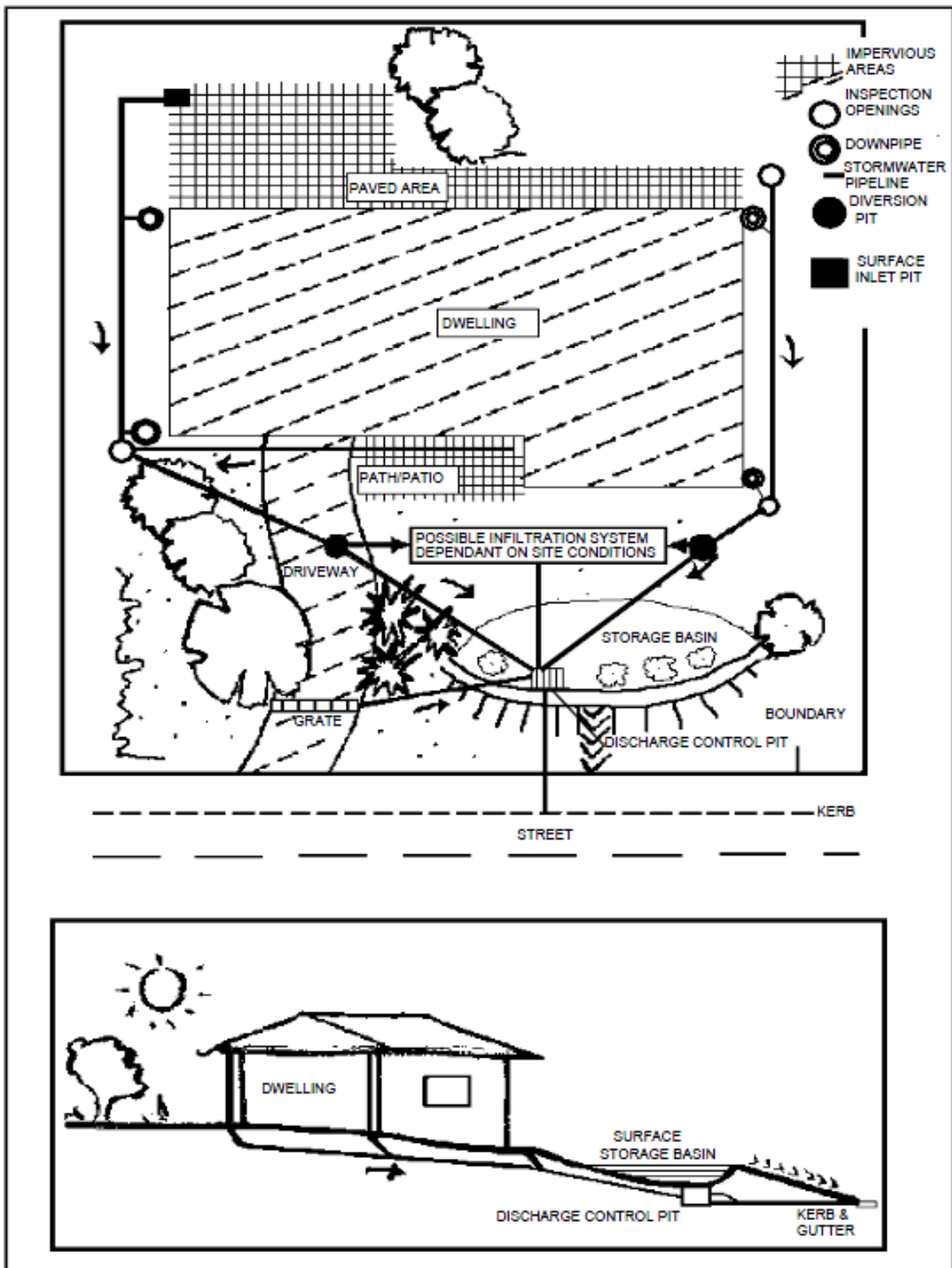

Figure 1-7 : Simplified Above Ground Storage System

1.4.3 OSD Design - Simplified Design Method

The simplified design method permits applicants to implement OSD systems without undergoing thorough or complex analysis. The approach is simply the application of Council's rates of permissible site discharge (PSD) and site storage requirement (SSR), based on the area draining to the OSD, to derive the require storage volume and permissible site discharge.

The simplified design method can only be used if the following site criteria are met;

- a) The type of development is single residential, dual occupancy or light industrial development,
- b) The total site area is less than or equal to 3000m²,
- c) A maximum of 25% of the impervious area bypasses the OSD system, and
- d) The discharge control must not be influenced by downstream water levels (i.e. must be able to freely discharge).
- e) The site is not located in a catchment draining to category 1 and 2 waterways.

The City of Ryde Council area drains to three main catchments labelled as Zone 1, Zone 2 and Eastwood Catchment as shown in the plan depicted in Appendix 4. Each catchment has separate permissible site discharge (PSD) rates and site storage requirements (SSR) suited for the characteristics of each catchment.

The catchment area used when determining the Permitted Site Discharge (PSD) rate and Site Storage Requirement (SSR) rate shall include the entire area that will contribute runoff to the detention storage facility during a 100 year ARI storm event.

The PSD and SSR provisions for each OSD catchment are given below in Table 1.4.

Catchment	Permissible Site Discharge (PSD) (L/sec/m ²)	Site Storage Requirement (SSR)(m ³ /m ²)
Zone 1	0.0265	0.0275
Zone 2	0.0265	0.0255
Eastwood	0.0210	0.0300

Table 1.4 Site discharge and storage coefficients.

Where 100% of the impervious area cannot drain to the OSD, the SSR and PSD shall be reduced to compensate for the smaller catchment draining to the OSD system. The modified PSD per square metre of catchment will be calculated using the following equation.

$$\text{Modified PSD} = \text{PSD} * ([A_t + A_b] / A_t)^{-1.37}$$

Where;

A_b = Impervious area bypassing the storage facility and

A_t = Total area draining to the storage facility

Wherever the PSD shall be reduced (say restricted to 30L/s if discharging to kerb and gutter) the SSR must be increased accordingly. The following formula may be used to calculate the adjusted storage volume:

$$ModSSR = 1.55I \times (PSD \text{ perm}^2 \times 10)^{-0.731} \times 1.2 \times 10^{-4}$$

Where;

I = Intensity of the 100yr – 2hr ARI storm event

= 56 mm/hr in Zone 1

= 51mm/hr in Zone 2 & Eastwood Catchment

Using the appropriate PSD rate and SSR rate based on the OSD catchment area, the OSD volume and orifice outlet size for the site can be determined by following the steps outlined in the On-site Detention Calculation Sheet contained in Appendix 3.

1.4.4 OSD Design - Detailed Method

The detailed method must be used in the following circumstances;

- Where the development does not satisfy the requirements for the simplified method above.
- Where Council considers the nature of the receiving system is too sensitive to warrant the simplified approach.
- Where the site conditions vary from those given in the simplified method.

The OSD must be designed to ensure the level of stormwater runoff discharged from the area of development must not to exceed the peak stormwater discharge arising from the post-developed works, during a 5 year ARI storm event.

To restrict post development flows to pre-development levels a detention basin for the design storms will be required to be modelled. Computational methods based on the approximate triangular method or the rational methods are not acceptable. It is recommended that a program in accordance with Section 3.1 is used.

In cases where the site proposes discharge to the kerb and gutter, the point of discharge is to be limited to 30L/s in accordance with Section 1.3.1.

If the rate of discharge from the outlet of the OSD system is affected by tail water conditions from the receiving system, for example where the invert level of the orifice is lower than the surface level at the point of connection into the existing drainage system, then full hydraulic calculations will be required in accordance with Section 5 of this Manual.

1.4.5 Rainwater Tank Offsets

Rainwater tanks do not generally substitute for the storage capacity required for on-site detention. However, where a rainwater storage tank for water efficiency is incorporated into a stormwater drainage system for a single occupancy development and the tank is connected to an internal re-use system, the volume of the required on-site detention may be reduced by an equal amount up to a volume of 5,000 litres for sites less than 3000m². This provision will be in addition to any BASIX requirements.

If a rainwater storage system is proposed for a larger development, some on-site stormwater detention offset may be given. The amount of offset shall be calculated from a water balance model

and consideration must be given to the maintenance of downstream open watercourse flows. This will apply on both public and private land as appropriate.

In some circumstances where it is difficult to provide OSD Council may consider waiving OSD requirements if the site proposes innovative stormwater management systems, including a large re-use rainwater tank and “rainsaver” system to compensate for inability to provide on-site detention. In such cases a detailed water balance model is required to show how many days the rainwater tank system is full and empty using a minimum of 10 years of rainfall data. Approval of such systems is at Council’s discretion only and will be assessed on its merit.

For rainwater reuse requirements for developments to size the rainwater tank please refer to Council’s manual “*Water Sustainable Urban Design Guidelines*”.

Rainwater tanks (above or below ground) can be designed to form part of an on-site stormwater detention system. A dual purpose OSD/rainwater re-use tank that collects only roof water from the roof may however allow the majority of stormwater runoff from the site to be uncontrolled. When using a dual purpose OSD/rainwater re-use tank the design must still ensure that the permissible site discharge for the whole site is still achieved. Storage tanks below ground will need appropriate pumps for their intended re-use purpose.

1.4.6 Orifices

The control outlet of an OSD system, the dimension and structural integrity of this component must be precisely detailed to ensure the system operates as intended. The following requirements apply to this component.

- a) Orifices are to be made of minimum 200 mm x 200 mm flat stainless steel, 3 mm thick.
- b) The orifice plate is to be tooled to the exact dimension as calculated.
- c) Orifice plates will need to be securely fastened in a central position over the outlet pipe using four (4) bolts and are to be flush with the wall to ensure that flow does not pass between the plate and the wall.
- d) Generally the minimum orifice size permissible is 40 mm ϕ to minimise blockages. Where the calculated orifice is less than 40mm ϕ the detention system should be redesigned to either reduce water depths in the storage facility or increase the catchment draining to the basin. The absolute minimum orifice diameter is 25 mm ϕ in accordance with Australian standards – however orifices this small will only be accepted at Council’s discretion where it is not possible or practical to reduce the water depth.
- e) The following formulas may be used to calculate the required orifice diameter.

$$Q = CA\sqrt{(2gh)} \quad (1)$$

$$d = \sqrt{(4A/\pi)} \times 10^3 \quad (2)$$

Where;

equation (1) is the orifice equation and equation (2) is the area of a circle equation.

Q is the flow rate in m³/s

C is the orifice coefficient which is 0.6 for a circular shaped square edge cut orifice

A is the cross sectional area of the orifice in m²

h is the pressure head at the middle of the orifice when the system is at its maximum storage capacity ie. the depth of ponding from the centreline of the orifice to the top water level in metres.

g is gravity being 9.81 m/s.

d is the diameter (mm)

π is pi = 3.1416

This formula assumes the water level immediately downstream of the orifice is not above its invert. Where a pipe with a small diameter is proposed for the outlet control (ie. for use with a rainwater tank OSD system) the orifice equation above may be used to calculate the discharge using an orifice coefficient of 0.8 for pipes.

Orifices sized according to depth of ponding and PSD can be read of the table contained within Appendix 5.

1.4.7 Debris Screens

A Debris screen or trash screen is a mesh insert placed inside pits, generally used with OSD systems to prevent the orifice/outlet pipe from getting blocked. It may also be required on-site prior to stormwater discharging the site to prevent gross pollutants and sediment entering the downstream water system. The following requirements apply to these components;

- a) Trash screens shall be constructed of hot dipped galvanized mesh, "Lysaght Maxi mesh Rh3030" (or an approved equivalent), for orifices or outlet pipes (or equivalent steel sections) of less than 150mm diameter. For orifices or outlet pipes (or equivalent steel sections) greater than 150mm diameter "WELDLOK (F40/203)" type mesh (or approved equivalent) shall be used. The cross sectional area of the screen shall not be less than 50 times the orifice cross sectional area for the Maxi mesh or 20 times for "WELDLOK".
- b) The screen or cage should be a minimum of 100mm from the face of the orifice or outlet pipe and attached (generally on a sliding mechanism) to the wall, but should be removable (without the use of tools) to permit cleaning and easy inspection of the outlet control. The use of any equivalent must be approved by Council's Engineer prior to installation.
- c) Any gaps between the trash rack and the pit wall shall be no greater than 3mm.
- d) A typical installation of a debris control screen is shown in Figure 1-8 below.
- e) A lifting handle welded to the top of the mesh is also required to allow for easy removal of the screen for cleaning purposes.
- f) The screen must not be bolted securely to the wall but should also not be easily removed.

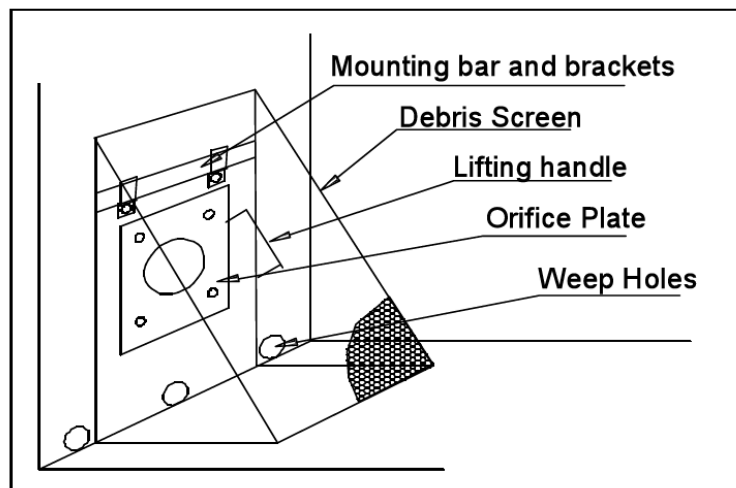

Figure 1-8 Debris screen.

1.4.8 High Early Discharge (HED) Systems

High early discharge (HED) systems work by routing stormwater runoff into a smaller secondary pit, located inside the OSD system at the location of the control outlet, allowing overflow to spill stormwater runoff to the main OSD storage. The stormwater runoff reaches its peak discharge rate faster as the water in the secondary pit fills up quicker due to the smaller area of the secondary pit.

By allowing a greater rate of runoff at the commencement of the storm event the OSD volume to be provided to restrict post development flows back to pre-development levels may be reduced.

HED pits can only be used in OSD systems that have been modelled with the detailed computational method. Hydrograph output for the pre-developed case and post developed case is to be provided showing that the maximum PSD for the site is not exceeded for all ARI storm events.

The following general items shall be adhered to in the design of detention storages and HED systems:

- a) A minimum of 85% of the area draining to the OSD system must drain directly to the HED pit/chamber.
- b) High Early Discharge (HED) pits are to be constructed as concrete cast "in-situ" pits. Precast or masonry brick pits are not permitted for HED pits.
- c) High Early Discharge pits up to a depth of 1200mm shall have a minimum internal opening dimension of 900mm x 900mm. For deeper pits, the HED pit shall have a minimum internal opening of 1200mm x 1200mm.
- d) The flap valve on the "return" from the storage area into the HED pit shall be a "Nicholas Flexi Flap" or approved equivalent. If an equivalent is proposed this must be approved by Council's Engineer prior to installation.
- e) Fittings in the HED pit are to be secured with "Ramset Chemical anchors (type M 10)" available from Ramset Fastener Pty Ltd or an approved equivalent. Any proposed equivalent must be approved by Council's Engineer prior to installation.
- f) The HED system shall have a min. 200mm sump provided below the orifice outlet to collect sediment. This sump is to have a minimum depth of 200mm below the invert of the orifice and it to be connected to the outlet pipeline by means of 3x40 mm weep holes plugged with a geofabric filter cloth. Between the weep holes and the connection to the pipeline a further filter medium is to be provided consisting of 15mm gravel wrapped in geofabric with a minimum length of 600 mm between the wall of the pit and the connection to the outlet pipeline. Alternative methods for draining the sump may be considered by Council; however the system above is generally preferred.
- g) A debris (trash) screen shall be installed in the discharge control pit over the orifice in accordance with the design requirements listed in Section 1.4.7.
- h) Pits shall be designed so that the discharge of "inlet" pipes is directed across the trash rack.

1.4.9 Operation and Maintenance

OSD systems are intended to regulate flows over the entire life of the development. This cannot be achieved without some regular maintenance. Routine maintenance of the OSD system is essential to ensure the system operates as intended in the design and to avoid unpleasant odours and health risks. For this reason Council requires a Positive Covenant to be placed on the title of the subject land to emphasise the proprietor's maintenance responsibilities and the preparation of a plan of management for the OSD system.

As part of the detailed design submission, a plan of management report is required for the OSD system detailing the operation and maintenance of the OSD system. The maintenance schedule is a simple set of operating instructions for future property owners and occupiers that should clearly and simply set out maintenance actions and the frequency of such actions accompanied by a simplified plan showing the layout of the OSD system.

Maintenance is the responsibility of the owner of the property. For safety, all maintenance access to underground storage systems must have due regard for the entry and safe working requirements set out in *AS 2865 Safe Working In a Confined Space*.

The following items must be addressed in the plan of management:

- Where all the components of the OSD system are located (i.e. pits, orifice, sump, storage areas),
- Which parts of the system need to be inspected and accessed for cleaning and how access is to be obtained,
- A description of procedures to gain access and carry out cleaning (including any equipment required, lifting devices or keys), and
- The frequency of maintenance actions (for example every 6 months and after every major storm event).
- The report shall include an inspection checklist and maintenance report record sheet for ease of use.

The frequencies of both inspections and maintenance will be highly dependent on the nature of the development, amount of vegetation, location of the storage and the occurrence of major storms. Generally all on-site stormwater detention systems shall be cleared of debris and sediment at least once a year to ensure correct operation of the system.

The debris screen should be removed and the orifice plate checked for obstructions. If water is not drained from the sediment collection sump within 48 hours of a rainfall event the weep hole filter bed may need renewing. For residential developments the system is to be inspected every six months and after each heavy rainfall event. For commercial and industrial developments the system is to be inspected every three months and after each heavy rainfall event.

The majority of OSD systems, particularly those where a large proportion of the storage is located above ground, will be able to be maintained by property owners, residents or handymen. Larger underground systems, particularly those with limited access and/or substantial depth, will require the owner to engage commercial cleaning companies with specialised equipment. The person required to do the work should be specified in the plan of management.

1.4.10 Design Requirements – All Systems

The following general items shall be adhered to in the design of OSD systems:

- a) In all cases, safety issues shall be addressed with provision of warning signs (including Confined Space Entry signs), and if necessary, safety fencing.
- b) Freeboard for any building adjacent to the detention structure shall be in accordance with Section 2.1 of this Manual.
- c) The drainage concept plan (to be submitted by the Applicant with the Development Application) shall identify undrained areas and include SSR, PSD and High Early Discharge (HED) discharge (if used), control pit design parameters such as pit levels, orifice levels/diameters, weir levels/flow rates, etc.
- d) All pits associated with the on-site detention system, (except for a HED pit if used), shall have minimum internal opening dimensions of 600mm x 600mm for pits up to 600mm deep, 600 x 900 for pits up to 900mm deep, and 900mm x 900mm for deeper pits.
- e) When a dwelling wall is proposed to form part of the containment wall for a storage area, or is adjacent to the storage area, it must have an impervious waterproof type membrane to prevent water seeping/penetrating or rising into the dwelling. Care must be taken to ensure that brick wall ventilation holes are *not* below TWL of storage area.
- f) A debris (trash) screen shall be installed in the discharge control pit over the orifice in accordance with the design requirements listed in Section 1.4.7.
- g) A maintenance schedule is to be prepared in accordance with Section 1.4.9.
- h) Major retention structures should be checked for Half Probable Maximum Flood flows so that damage, resulting from failure of the structure, does not occur.
- i) An outlet structure or overflow weir shall be designed to safely convey the 100 year ARI storm event on the assumption that at commencement of the design storm the detention outlet is 100% blocked.

- j) Where overflow is through an adjoining property and a suitable overland flow path is not available, the overflow should be collected within a drainage pipeline with a design capacity equivalent to the 100 year ARI storm runoff from the site.
- k) Suitable scour protection in accordance with Landcom's "Managing Urban Stormwater – Soil and Conservation – Volume 1" 4th Edition 2004 (Blue Book) or similarly recognised publications shall be used over any spillway.
- l) Where plastic modules are proposed, a minimum of two cleaning eyes into the tank must be provided and all inlet pipes must be directed to an external control pit that has a screened connection to the tank with a surface area of at least 0.25m².
- m) All OSD storage must be located above the flood level or downstream water level to provide effective storage. Where there is a submerged outlet it shall be modelled with a computer program to ensure it functions hydraulically as intended to limit post development flows to pre-development levels. Submerged outlet will require HGL analysis.
- n) A sediment collection sump is to be provided below the orifice outlet to the stormwater detention system. This sump is to have a minimum depth of 200mm below the invert of the orifice and it to be connected to the outlet pipeline by means of 3x40 mm weep holes plugged with a geofabric filter cloth. Between the weep holes and the connection to the pipeline a further filter medium is to be provided consisting of 15mm gravel wrapped in geofabric with a minimum length of 600 mm between the wall of the pit and the connection to the outlet pipeline. A typical sediment collection sump with drainage filter is shown in Figure 1-9 - Typical sediment collection sump. Alternative methods for draining the sump may be considered by Council; however the system above is generally preferred.

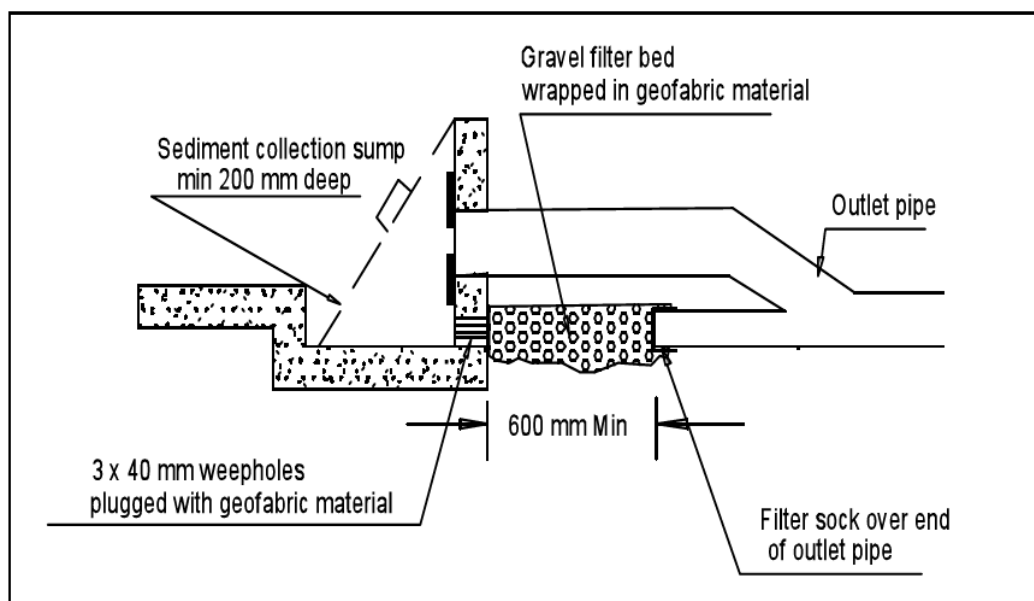

Figure 1-9 - Typical sediment collection sump.

- o) Each on-site stormwater detention system shall be indicated on the site by fixing a marker plate in a prominent position. This plate is to be of minimum size 150 mm x 100 mm and is to be made from non-corrosive metal or 4 mm thick laminated plastic. It is to be fixed to the nearest concrete or permanent surface in a prominent position. The wording on the marker plate is to be as per Figure 1-10 - Onsite detention system marker plate.

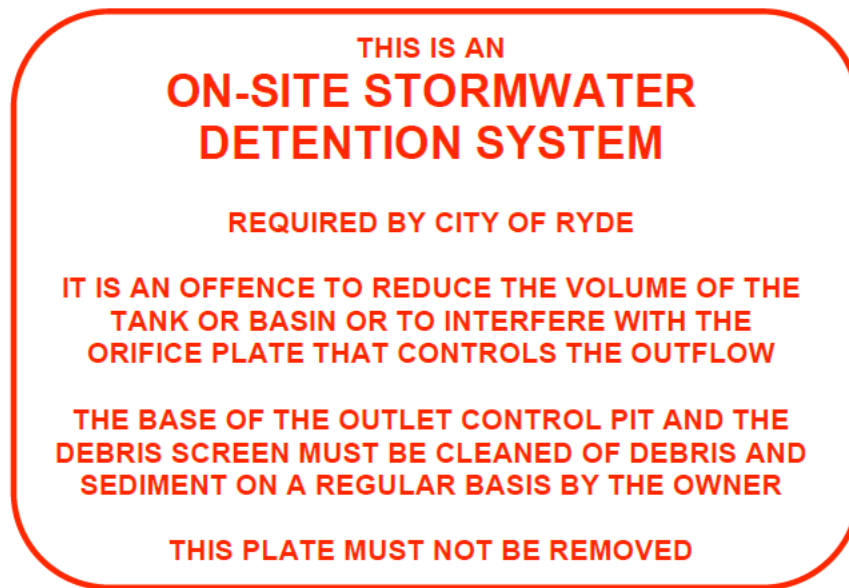

Figure 1-10 - Onsite detention system marker plate.

1.4.11 Design Requirements - Above ground systems

- a) When using rainwater tanks for OSD, consideration must be made to the appropriateness of using an orifice outlet as the discharge control as it may be difficult to construct as it is not a common rainwater tank fixture. It is therefore preferred when using a rainwater tank for OSD systems that the outlet control is an appropriately sized pipe. The use of an equivalent pipe diameter in place of an orifice is not acceptable as the discharge through a pipe is not the same as through an orifice of the same diameter. Please refer to Section 1.4.5 for the appropriate method of calculating discharge for OSD outlets.
- b) Minimum desirable slope of 1% in paved areas and absolute minimum of 1% in landscaped areas.
- c) The storage depth in car parking and driveway areas should generally not exceed 150mm, with an isolated maximum depth of 200mm being permissible at low points in the detention area.
- d) In large landscaping areas used for detention mulch is not to be used.
- e) Above ground storage areas shall generally incorporate “Walk in” and “walk out” batters with a maximum slope of 1 vertical to 5 horizontal (1V:5H). Where this cannot be achieved an absolute maximum slope of 1V:4H shall be used with consideration made to maintenance access.
- f) Where a ‘walk in” and “walk out” batter of 1V:5H cannot be provided and/or the maximum storage depth is in excess of 600mm a risk assessment is required with documentation to determine whether a 1.2m high safety pool fence with child proof self closing gates or better is required to restrict access.
- g) Steps must be provided where the step down to storage invert exceeds 200 mm or for “fenced” storage areas where maximum allowable slope cannot be achieved.
- h) Above ground systems must be designed to not restrict pedestrian access from the public road to buildings.
- i) The storage volume must be increased by 20% in landscaped areas to allow for growth of vegetation and minor variations to the ground level that will occur as part of the general maintenance. The 20% additional volume is to be gained by increasing the surface area of the ponded surface. Increasing the depth of the basin to gain additional storage is not permitted as this will alter the designed stage-storage discharge relationship of the model.
- j) Have a volume of less than 10,000L where the basin is located within the front setback of a single occupancy development.

- k) Any above ground storage for medium density developments must be located in common areas (not in private courtyards etc) and not in the front setback of the development.
- l) If an earth mound is used to retain water the crest width (berm) is to be no less than 1.0m wide.
- m) Large systems may require approval of the Dam Safety Committee.

1.4.12 Design Requirements - Below ground systems.

- a) A minimum internal (head) height of 1.2m is to be provided. This may be reduced to 750mm for commercial/industrial development or 500mm for residential development, but only where all other practical alternatives have been exhausted and where it can be demonstrated that consideration has been made to allow easy access by the owner of the system to facilitate inspection and maintenance and having satisfied the requirements of Confined Spaces Act and Occupational Health & Safety Act 2000.
- b) Underground storage facilities shall be designed to adequately withstand all service loads and provide adequate service life of 50 years.
- c) Sufficient ventilation and access points (usually hinged grated lids) must be provided to the storage tank.
- d) All grates accessing the tank shall have industrial grates with a maximum lifting weight of 20 kg. The grate may need to have a double opening in order to achieve this requirement.
- e) Grates are to be placed in a manner to ensure that the maximum distance from any point in the tank to the edge of the nearest grate is not greater than 3m. This is to facilitate access and maintenance of the storage tank.
- f) The base of the tank shall be shaped with a min. 1% cross fall to a central "V" drain, and min 1% longitudinally slope along the "V" drain to ensure long term ponding of water will not occur over the floor of the basin.
- g) The designer shall avoid placing access points/grates in driveways to minimize danger to service personnel during maintenance works. Where this cannot be avoided, the grates must be designed to withstand vehicular loads.
- h) Suspended pipes through underground storage spaces shall be avoided wherever possible. Where they are unavoidable the following requirements shall apply:
 - i) Concrete pipes, in tanks, must be supported by concrete cradles with a minimum clearance of 50mm between under side of pipe and the tank floor.
 - j) PVC pipes must be secured to wall brackets or roof brackets. The resultant system shall be rigid in all directions.
 - k) Vertical walls shall be finished smooth so that they cannot collect litter and debris. Walls will generally satisfy this requirement if they are:
 - l) Block walls with flush joints
 - m) Concrete wall with smooth surface
 - n) Horizontal and near horizontal surfaces inside pits shall be finished with a wood float finish.
 - o) Step irons shall be provided where pit and/or tank depths are in excess of 1.2m
 - p) Below ground storage facilities shall be located outside the root zone of trees that must be retained.
 - q) Below ground facilities shall have a minimum soil cover in landscaped areas of 300mm.
 - r) Venting must be provided where gas build up is likely. A hydrostatic valve must be provided where necessary.

1.5 Trunk Drainage Design

Release areas or very large infill developments will require the design of trunk drainage infrastructure. Council's basic philosophy is that natural creek lines and watercourses must remain largely intact and continue to function as viable ecological systems. Where the existing riparian environments are largely degraded, Council expects that the trunk drainage design will address this issue and restore ecological and habitat systems to mimic the natural condition of Sydney creek lines as closely as is practicable.

Council recognises that urbanisation of natural or rural developed catchments will inevitably alter creek hydrologic and geomorphologic regimes. However, the design of any trunk drainage system must recognise and address these constraints whilst proposing solutions/designs that integrate with Water Sensitive Urban Design principles and mimic natural flow regimes and restore/enhance/maintain the existing riparian environment and floodplain.

Council is primarily interested in superior aesthetic, environmental and recreational outcomes for riparian corridors, which are a very valuable community resource. Leading edge or innovative trunk drainage design strategies will be assessed on their merits.

A low maintenance, naturalised, landscaped watercourse and floodplain is Council's preferred outcome. Hard engineering structures are to be avoided wherever possible in favour of more natural rock walls, riprap scour protection etc. However, rock outcrops are not common along Sydney creek lines and are only to be used where potential or existing scouring of creek beds and banks require such measures. Suitable select sandstone is preferred to igneous rock such as granite, basalt, dolerite etc. and interlocking loose packed rock walls and riprap is preferred over gabion or mattress type structures.

Bridges are preferred to Reinforced Concrete Box Culverts (RCBC's) at road crossings and must facilitate the movement of fauna and provide for fish passage where appropriate. Landscaping must reflect indigenous flora representative of the natural riparian environment of Sydney creek lines. The design should aim to achieve a slow moving, steady flow regime to minimise scouring potential and maximise safety outcomes. Rock drop structures, incorporating low flow riffle zones, and dense (increasing floodplain roughness) riparian plantings may help achieve these outcomes on steeper sections of some watercourses.

The design and construction of the trunk drainage shall be in accordance with the hydraulic requirements as per Section 5.

1.6 Drainage for low level properties

The following procedure describes the requirements for discharging water for single residential low level properties only. Multi-unit developments, industrial, commercial and subdivision developments that are low lying properties that cannot drain to a preferred discharge point must acquire or have access to an easement to drain via gravity feed system.

Generally, Council is to be satisfied that an honest attempt and reasonable attempt has been made to acquire an easement through any of the downstream properties or demonstrated that all avenues to establish an easement be impractical or unviable, prior to consideration of an alternative means of stormwater discharge from the site.

Applicants are to firstly approach all downstream property owners, wherever a drainage easement to drain the subject property could be established. Any request for a drainage easement must outline details of the proposed easement as well as present a monetary offer of compensation for the easement. The written request is to be generally in accordance with the proforma letter contained in Appendix 14. Council requires some written evidence to clarify that some negotiation has been undertaken with the property owner.

Where a neighbouring owner refuses to grant a drainage easement the applicant must provide documentary evidence of this outcome.

Section 88K of the *Conveyancing Act 1919* allows for the compulsory acquisition of an easement over land if the easement is reasonably necessary for the effective use or development of other land that will have the benefit of the easement. There are a number of criteria outlined in the Act that must first be satisfied.

If the property owner is unable to attain any written response from the adjacent downstream property owner, a Statutory Declaration stating the above must be submitted.

Council may, at its discretion consider other methods of stormwater disposal only if all of the above mentioned methods have been exhaustively investigated and were considered not appropriate for this development.

1.6.1 Section 88k of the conveyancing Act 1919 (NSW)

Where a drainage easement is not able to be obtained through a negotiation process with adjoining owners it is possible to have the matter dealt with by arbitration in the Supreme Court through the *Conveyancing Act 1919 (NSW)* (the Act), s 88k. The rationale behind the introduction of the section was expressed by the Attorney General in December 1995 where he pointed out that the introduction of s.88k:

“..reflect(s) .. a realisation that private developments may also be beneficial for the public, and that such development should not be unreasonable frustrated or held to ransom.”

Essentially to be successful under Section88k, it is necessary to establish the following:

1. The easement is reasonably necessary for the effective use or development of the land that will have the benefit of the easement.
2. That the use of the land in accordance with the easement is not inconsistent with the public interest.
3. That the owners of the land to be burdened by the easement and each person having an estate or interest in that land can be adequately compensated for any loss or any other disadvantage that will arise from the imposition of an easement.
4. That all reasonable attempts have been made by the applicant to obtain the easement otherwise than approaching the court.

In making an order under Section88k the court is to

- a) Specify in the order the nature and terms of the easement, and such particulars referred to in s 88 (1)(a)-(d) as are appropriate, and is to identify its site by reference to a plan that is , or is capable of being, registered or recorded as a Deposited Plan.
- b) Provide in the order for the payment by the applicant to specified persons of such compensation as the Court considers appropriate, unless the Court determines that

1.6.2 Building adjacent to Easements, Piped Drainage Systems or Natural Watercourses

No encroachments or low lying overhangs of developments are permitted over and/or within easements for stormwater drainage or over piped drainage systems or over natural watercourses. On a merit basis, Council may allow light, easily removable structures to be built over drainage easements, piped drainage systems or natural water courses, e.g. Carports or paved areas which can easily be removed and replaced.

An overhang, over and/or within an easement will be considered on merit. A minimum vertical clearance to allow appropriate machinery to allow easy access and ample clearances to undertake maintenance replacement operations is required. Alternative construction techniques to allow removal of sections of the building structure by the property owner will also be considered.

Demountable carports and other easily removable structures that do not involve usable floor space, have been approved over Council drainage easements. If approval for such a structure is granted, the owner would need to place a “Deed of Charge” on the title of the lot that is binding on successors in title, indicating that the property owner will remove the structure at their own expense if Council deems it necessary for the purposes of accessing the easement. Any such approvals will not extinguish or limit Council’s rights under the easement. Pedestrian and vehicular bridges may be permitted to encroach an easement provided they can be easily removed to facilitate access to the easement and suitable alternate vehicular and pedestrian access to the property exists if they were removed.

Structural support elements are not permitted within easements or within the cross sectional area of an open or natural watercourse. Structural support elements adjacent to an easement, piped drainage or natural water course located on the development site or on adjacent lands must be founded outside the zone of influence (or as directed by the structural engineer) to provide stability to both the structure and drainage system particularly during maintenance operations. Typically, where a drain is laid near to a footing the trench shall be located beyond a 45° angle from the base of the footing. Allowance needs be made for future upgrading of the pipeline to handle larger storm events. Figure 1-11 - Drainage easement adjacent to a building. , shows an example of drainage easement adjacent to a building.

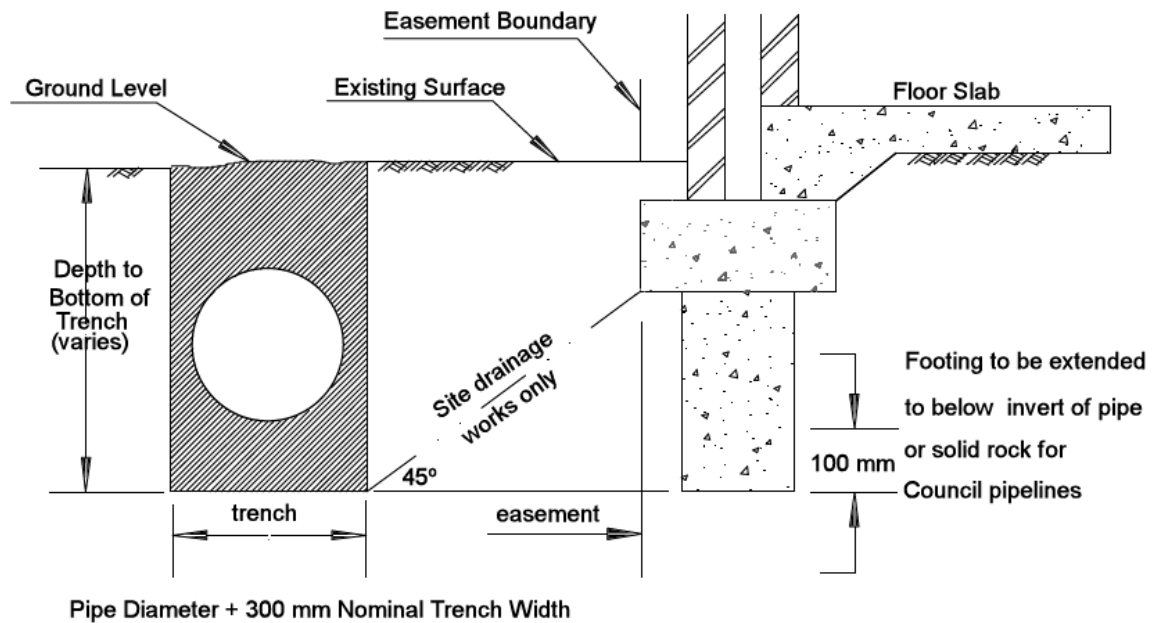

Figure 1-11 - Drainage easement adjacent to a building.

Where an easement across a property contains a pipeline conveying stormwater runoff from roads and parkland, the footing must be extended to a point a minimum of 100 mm below the invert of the pipe or to sound rock. The minimum width of this type of easement is 2.5 metres. If an existing easement is less than 2.5 metres, a setback from the easement boundary to allow for this width of access will be required.

Council will generally not approve the construction of any permanent structure or the placing of filling over a piped drainage system or easement that will prevent or hamper constructing, reconstructing, maintaining repairing, cleaning or gaining access to the pipelines or easement. Permanent structures include habitable dwellings, eaves & balconies, garages, impervious fences, swimming pools and retaining walls.

Consideration may be given in exceptional circumstances to permanent structures subject to an adequate and safe overland flow path being provided and a minimum of 8 metres clearance over the 1 in 100 year flood surface levels. This shall include eaves and balconies. On-ground vehicular driveways and landscaped areas will typically be permitted over an easement however the structural stability of any existing pipelines may need to be considered before consent is given to an application that proposes to introduce additional live loads to the pipeline. Similar considerations will be made when it is proposed to reduce cover over the pipe. Masonry walls constructed across an easement must cross the easement at an angle of not less than 60°. The section of wall spanning the easement shall be constructed to enable its easy removal without resulting in failure of the remainder of the structure. The footings must be constructed to prevent any loading imposed on the pipe.

2 FLOODING AND OVERLAND FLOW

It is essential that development be designed with consideration to flooding and overland flow due to stormwater runoff, from both minor and major storm events. Whilst the following section mostly addresses property affected by major flooding and overland flow, all property development must be mindful of the minimum freeboard requirements as specified following.

2.1 Freeboard requirements

The following table specifies minimum freeboard requirements based on type of overland flow and category of the development to ensure that such development is not subject to stormwater inundation or nuisance flooding.

Drainage System/ Overland Flow	Residential			Industrial/ Commercial	
	Land Level ^(b)	Habitable Floor Level	Non-Habitable Level ^(c)	Land Level ^(b)	Floor Level
Surface Drainage/ adjoining ground level ^(a)	-	.15m	-	-	.15m
Public drainage infrastructure, creeks and open channels	0.5m	0.5m	0.1m	0.3m	0.3m
Flooding and Overland Flow (Overland Flow Precincts and Low Risk)	N/A	0.3m	0.15m	N/A	0.3m
Flooding and Overland Flow (Medium Risk and greater)	N/A	0.5m	0.3m	N/A	-
Onsite Detention ^(d)	N/A	0.2m	0.1m	N/A	0.2m
Road Drainage Minor Systems (Gutter and pipe flow)		0.15m below top of grate			
Road Drainage		Refer to Figure 2-1.			
Detention Basins ⁽⁴⁾		The top water level shall be designed to be 0.5m below top of embankment (100yr ARI)			

Table 2.1 Freeboard requirements.

Notes:

- a. Reduced for site specific conditions (surface grades, extent of stormwater runoff, etc). Generally the intent is to prevent inundation by stormwater runoff on the site.
- b. Land level at subdivision stage.
- c. Non-habitable structures such as sheds etc.
- d. Refer to Section 1.4 for OSD design requirements.

It may be necessary for a structure to be checked against Probable Maximum Flood (PMF) event in areas where failure could significantly increase the danger to life and property. The freeboard may need to be increased where there are high flow rates, high flow depths, and/or potential damages in the event of stormwater inundation and/or low confidence in the accuracy of the prediction model. An adverse combination of factors may result in a freeboard of 500 mm or greater being required.

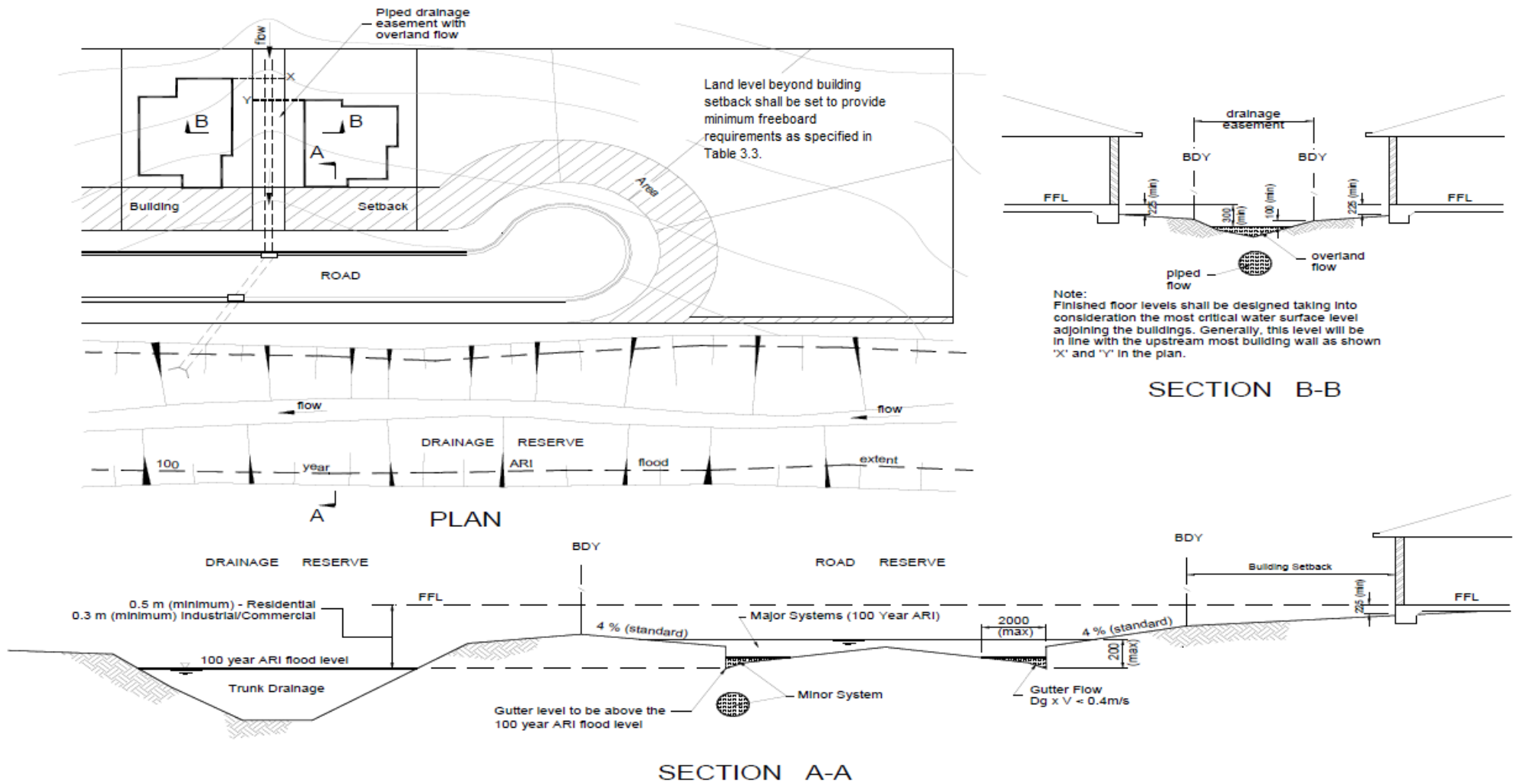

Figure 2-1 Typical freeboard requirements.

2.2 Preparation of a Flood Impact Statement

Certain areas within the City of Ryde are prone to major overland flows and flooding resulting from large storm events. Development works undertaken on land that is subject to these natural occurrences must therefore be designed to ensure the resulting development satisfies the Council's DCP objectives in relation to flooding and overland flows.

To assist in the assessment of development on land affected by flooding and major overland flows, a Flood Impact Statement must be prepared and submitted as part of any development application on land marked as subject to flood affectation unless the development is notably clear of any areas of flooding or overland flow path on the property. As a guide, this will be when the development works are founded (located on natural ground level) at least a metre above the marked extent of flood inundation on Council's mapping system. In some areas, Council's flood data is indicative only (based on the general topography, size of the upstream catchment and historical flood records) and does not take into account particular site characteristics or inground drainage infrastructure. As such, Council may request a Flood Impact Statement in situations where the specific site conditions and flood regime may present a risk to the development.

The intent of the Flood Impact Statement is to ensure that;

- site specific conditions are taken into consideration of the development with respect to flooding impacts,
- the objectives and controls of Councils DCP and Technical Manual are appropriately addressed.
- the statement is to provide recommendations to be implemented during the detailed design and construction phase, as well as during ongoing operation of the development.

The format of the Flood Impact Statement, outlined below, must address the planning considerations with respect to the estimated flood level and flows resulting from the 100yr ARI storm event, or the PMF for critical components where required.

The required level of detail of the supporting information may vary considerably from site to site, depending partly on how close the proposed development is to the criteria limits. The proposed location and shape of buildings and other structures will often have a large influence on overland flow characteristics. For this reason the early involvement of a qualified and experienced Drainage Engineer is recommended in the conceptual design phase.

The Flood Impact Statement must be prepared by a suitably qualified and practising Drainage Engineer, suiting the qualifications and skills listed in Section 3.1.2 (Drainage Consultant Qualifications).

2.2.1 Determining Flood Risk

Council has commenced and completed flood studies for several catchments in the Council area. Where this analysis has been completed, site specific flood information can be obtained from Council and must be utilised in the preparation of the Flood Impact Statement. Refer to Councils website or the DA Guideline for Flooding and Overland Flow in regards to obtaining this information.

In locations where site specific flood information is not available, the Flood Impact Statement will need to determine the level of flood risk, the scope of works proposed however will determine the appropriate level of detail for this to be determined.

For some development, The Flood Impact Statement may be required to undertake a catchment analysis in order to determine the flood levels resulting from the 100yr ARI storm event and in some cases the PMF for significant development.

Council acknowledges that for minor development, the cost of this exercise can be onerous relative to the cost of works. For this reason, several of the planning considerations to be addressed in the Flood Impact Statement contain concessional provisions, allowing the adoption of conservative assumptions and/ or measures to address the component.

2.2.2 Flood Impact Statement Structure - Planning Considerations

The requisite planning considerations to be considered in the Flood Impact Statement listed in the following section.

Several provisions may be applied for concessional development and are outlined under the term “*Concessional Provision*” below. These may only be utilised where permitted under Section 3 of the DCP Part 7.3 (*Stormwater and Floodplain Management*) (herein referred to as the “DCP”).

1. Description of the Flood Regime

To establish the applicant and consultant has a full understanding of the flood affectation and its relation to the development, the Flood Impact Statement must include a summary of the flood affectation and its relation to the proposed development which is site specific. This may be way of plan or description however should be site specific. Where detailed flood level information is not available, the report is to present an analysis of overland flow in accordance with Section 4 (HYDROLOGY).

Concessional Provision:

For development categorised as “Concessional” as per the DCP definitions, a general estimation of flood affectation may be presented. This may consist of (but not limited to) a simplified catchment analysis estimating overland flow and the depth of flow given the proposed flow path and site conditions. The intent of this is to ensure that the proponents of the development have a comprehension of the level of flood affectation over the site. The level of detail can be representative of the scope of development and conservative assumptions would be accepted.

2. Floor Levels

Development should provide a freeboard above flood levels resulting from the 100yr ARI storm event in order to protect it from inundation. Refer to Section 2.1 in regards to the freeboard requirements.

Concessional Provision:

Where permitted by Section 4 of the DCP, the floor level of new works must be no less than the existing maximum freeboard provided above natural ground level by the existing development.

3. Building Components

Any new development works subject to flooding and overland flows should be constructed of flood compatible materials to ensure the structural integrity of the works is maintained throughout and after a flood event. For a majority of development, this is not a crucial aspect to be addressed prior to development consent however will be enforced as a condition of consent. It is then warranted this aspect be considered in the design phase.

4. Structural Soundness

Proposed developments shall be designed to withstand damage due to scour, debris or buoyancy forces. Additional measures, including site drainage need to be considered with slab on ground construction. As per above, this is not a crucial aspect to be addressed prior to development consent

however will be addressed as a condition of consent. It is then warranted this aspect be considered in the design phase.

5. Flood Effects

Due regard is to be given to the location and shape of proposed buildings on the site with respect to the diversion of overland flow and flood depth, not only on the site but also to neighbouring properties.

Development must avoid;

- Concentrating overland flow through the property, increasing the risk to occupants and neighbouring properties.
- Promote the increased use of a property (or part of a property) that has an existing stormwater inundation safety hazard.
- Reducing flood storage.
- Diverting overland flow such to increase flood depth or affectation on neighbouring properties.

Assessment of this component will consider the degree of affectation, risk to occupants and neighbouring residents, the impact of potential development on the neighbouring sites and the level of measures the applicant has resorted to minimise these impacts.

In most cases, this component will require an analysis of the pre-developed and post-development conditions in the Flood Impact Statement to gauge these flood effects, using HEC-RAS or simplified open channel analysis if the site conditions (and the overland flowpath is uniform).

For sites where flood level information is available, the issued flood level information should be utilised to calibrate the model.

Concessional Provision:

To fully address this consideration requires the determination of flood levels and flows which can be a costly exercise for small scale development. Given concessional development typically presents minor alterations to building footprints, this component will not require further consideration if;

- The proposed works are designed to allow for the free passage of flows (eg the development is suspended above natural ground level).
- Where the above point cannot be achieved, the proposed works are designed to limit the level of exposure to overland flow such that, the extension of the footprint towards the centreline of the flow path, is no more than 15% than existing (at least 85% open space). The centreline of the flowpath is to be generally taken as the invert of a natural valley, depression or sag traversing the site (in other words, the path of which overland flow will follow) or where it is likely to be constricted by a neighbouring dwelling, midway to that dwelling. Refer to Figure x.x for examples.

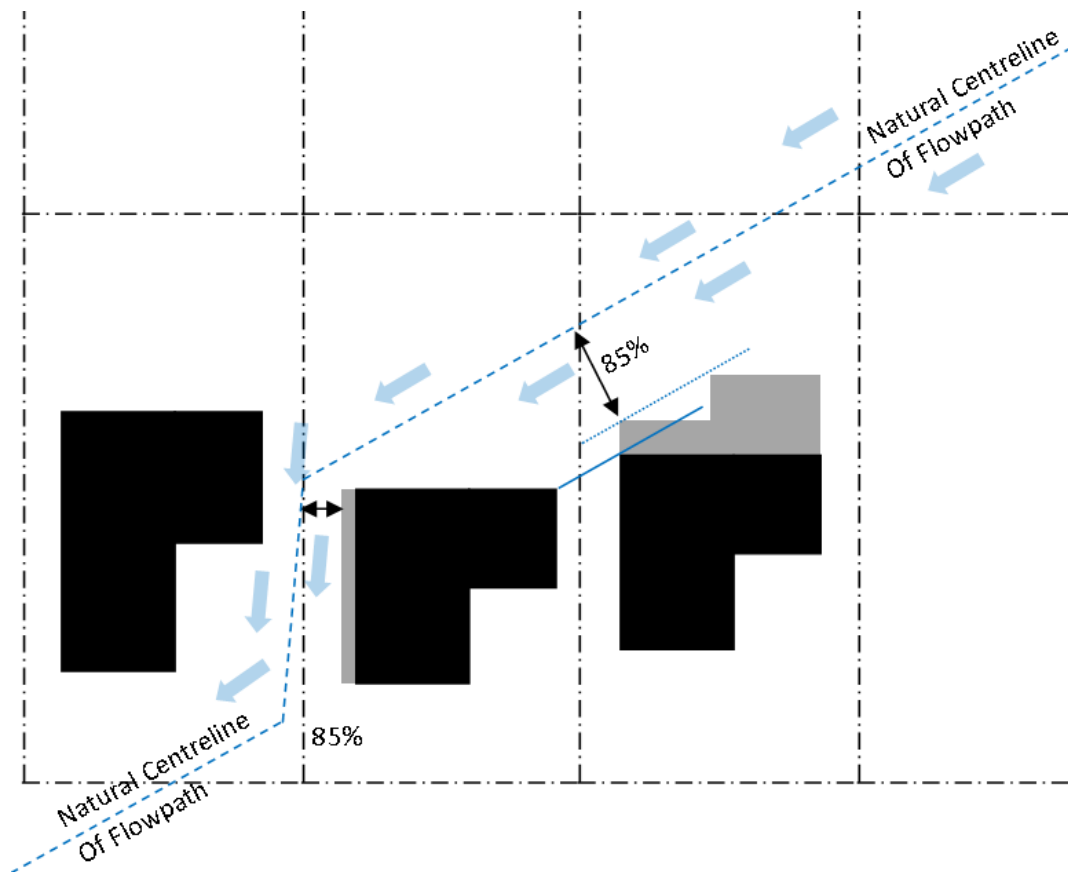

Figure 2-2 - Example of provisional flood effects consideration

Evacuation

Consideration for the escape from flood waters must be outlined in the flood impact statement, to ensure development does not jeopardise public safety. The site must have access to a safe refuge above the PMF event.

Management & Design

Access must be considered, especially with regard to occupants and vehicles leaving a site.

Proposed land subdivisions of lots affected by 'Local Drainage' will not be approved unless the applicant can demonstrate to Council that it is possible to provide a development on the newly created lot that realises the full floor space ratio (FSR) potential of the lot and provides suitable private open space while meeting the Local Drainage management criteria outlined in this document.

Suitable finished ground levels are often critical to ensure that overland flow is adequately conveyed through the property. Further, the inappropriate placement of landscaping features can seriously compromise or undo an otherwise sound overland flow management scheme.

All building plans must show sufficient finished levels to ensure builders will not inadvertently compromise the system for safely conveying overland flow through the property.

A suitably qualified hydraulics engineer must review the building plans, including the landscaping plans, and submit a Compliance Certificate confirming that the building and landscape plans are fully consistent with the approved overland flow management strategy. The engineer will also be required to inspect the completed development and certify that it is fully consistent with the approved overland flow management for this site.

1. A survey of the area affected by overland stormwater flow through the site, and adjoining properties where necessary, undertaken by a Registered Surveyor, showing all physical features which will affect the position and depth of floodwaters. This shall extend sufficiently upstream and downstream to ensure relevant hydraulic controls are contained within the survey.
2. A hydrological analysis of the upstream catchment and a hydraulic analysis of the relevant section of the piped drainage system, to determine overland flow rates through the site in accordance with Section 4, Section 5 and the design requirements in Section **Error! Reference source not found.**. Where known, these flow rates will be supplied by Council.
3. A hydraulic computer model to assess the pre-developed and post developed scenario flow regime.
4. A comparison of water levels, depths, velocities and hazard classifications across the site between the pre-developed and post developed scenarios.
5. An engineered post developed overland flow path(s) to safely convey waters.
6. Plans and calculations of the pre-developed and post-developed position, depth and velocity of the floodway through the site, and adjoining properties where relevant, prepared by a suitably experienced, qualified Civil Engineer.

All developments must not increase the quantity of flow, water levels or water depths through adjoining properties upstream, downstream or alongside of the site. Water depths within the development site may be increased where it can be shown that the design criteria listed below can be achieved. Regardless of what the pre-development velocities are through the site or adjoining properties where it is proposed to change the flow regime the Vd product must comply with the design requirements listed below.

2.3 Flood Analysis

Free surface hydraulic analysis of flow over properties in an urban environment is a complex process. Buildings and other obstructions can cause rapid variations in overland stormwater flows over a relatively short length. The direction of flow can change abruptly and the roughness of the surface can be highly variable. Engaging a suitably qualified engineer with experience in this field and an understanding of the complexities involved is essential. A poor choice of consultant can lead to significant delays and frustration.

When undertaking an analysis of an existing piped drainage system to determine peak overland flows careful consideration must be made to the blockage factors applied to the system and whether the system is governed by inlet control or outlet control.

Where the upstream catchment draining to the pipe system contains any open channels, headwalls or other open systems a 50% blockage factor is to be applied directly to the pipe running through/adjacent to the site where the overland flow analysis is being done, by modelling the pipe with an equivalent surface area equal to half the actual pipe size (i.e. a 750mm DIA pipe with 50% blockage is equivalent to a 525mm DIA pipe). Where the size and number of pit inlets in the catchment are unknown or it is impractical to gather the information for such a catchment a 50% blockage factor is also to be applied directly to the pipe.

In instances where the development is in a drainage sensitive area identified by Council where inadequate drainage has been provided it is possible that the pit inlets themselves are acting as the control governing what flows are actually contained within the pipe system. In such cases applying a

blockage factor to the pipe system is not acceptable; blockage factors listed in Section 5.5 shall be applied to the pit inlets to determine pipe flows and the resulting overland discharge.

Consideration must be made to adopting appropriate tail water levels.

2.3.1 Gauging Flood Hazard

To gauge the level of flood hazard a property is exposed to, both velocity x depth (Vd) limits and safe water depth limits should be observed. These limits must be strictly observed when designing flow paths on medium density residential property developments.

The depth x velocity product (Vd product) in the kerb and gutter should not exceed 0.6 m²/s (AR&R, 1998) to reduce hazard for pedestrians within the roadway. However, where there is an obvious danger of injury or loss of life, the Vd product shall be limited to 0.4 m²/s.

The Vd product of overland flows in all other cases (across the footpath, within the road reserve, through properties) shall be such that the safety of children and vehicles are considered and restricted to below 0.4 m²/s.

The peak Vd product of stormwater runoff through areas accessible to children or the elderly (such as schools, hospitals, community centres, libraries and other as specified by Council) shall be further limited to the stability values provided in **Error! Reference source not found.** Such areas include driveways, car parking spaces, pathways and courtyards.

Depth of Flow (m)	Limiting Stability Value of Depth x Velocity for 100 year ARI storm event
0.05 or less	0.15
0.1	0.22
0.2	0.29
0.3	0.33
0.4	0.35
0.5	0.33
0.6	0.31
0.7	0.26
0.8	0.16

Table 2.2 Maximum Vd products in areas accessible to children and the elderly.

2.4 Fencing and Landform

Changes to the landform and fencing are rarely considered in the context of flooding and overland flows however can have consequences in terms of diverting flows or reducing flood storage. The following requirements apply to such structures on flood affected lots.

- a) Safety fencing necessary to restrict access to area affected by hazardous flows shall meet the minimum standards outlined in *AS 1926.1-1993 Fencing for Swimming Pools*.
- b) Boundary and internal fences should not obstruct the natural path of overland flow.
- c) All fences located within an overland flow path shall be permeable in nature to at least 300 mm above the calculated top water level in order to allow water to freely pass through them. In most instances, only the lower portions of the fence will need to be permeable.
- d) All light structures such as garden sheds, fencing and above ground portable pools are likely to be removed due to major overland flows. Consideration should be given to the potential impacts of this debris.
- e) Consideration is to be given to potential for property erosion due to scour by overland flows. The potential for scour is a function of the velocity of the water and the type of surface over which the water is passing.

2.5 Piping overland flow

Proposals involving collecting and piping overland flow through the subject property or upgrading a section of Council's existing pipe infrastructure to address flooding will generally not be acceptable for the following reasons:

- a) The reliance of a drainage system in the absence of a defined overland flowpath is prone to failure.
- b) There is a substantial potential for system blockage due to the limited number of inlets available.
- c) The natural detention storage available within the catchment is reduced and flow velocities are increased.
- d) Due to the greater rates of flow, it may cause localised increase in flood hazard at the system outlet and greater scour of natural creeks and/or disturbance of the downstream river bed.

3 ENGINEERING DRAWING AND REPORT REQUIREMENTS

3.1 Stormwater Drainage Submissions

3.1.1 General Requirements

Stormwater documentation including concept stormwater plans, detailed stormwater engineering plans, supporting calculations and reports are required to enable Council to assess the proposed development.

Submissions light on detail that do not address the submission requirements listed in this Section will most likely be returned to the applicant with a notification for further information to be provided or in some cases will be rejected. With the view of having a smooth streamlined process for development applications and approvals without delays it is essential that the information requirements listed in these sections are addressed.

Stormwater concept drawings shall generally accompany the local development application (LDA). In certain circumstances where the site is in a drainage sensitive area detailed drawings may be required at DA stage. Detailed stormwater drainage drawings are required to be submitted with any construction certificate application.

Full stormwater engineering drawings with supporting calculations and reports shall generally accompany the Local Development Application. Concept stormwater drainage plans will only be permitted for small developments with minor drainage works, where the following criteria are met:

In general the level of information must be sufficient to demonstrate compliance with Council's controls which may require additional information for sensitive drainage/difficult sites.

3.1.2 Drainage Consultant Qualifications

Drainage plans and calculations must be prepared by persons having appropriate qualifications in the design and analysis of stormwater drainage and runoff. The following are considered to be acceptable accreditation for the purpose of stormwater drainage design and certification:

- NPER in Civil Engineering (Institution of Engineers, Australia),
- Surveyors certificate of Accreditation in Onsite Detention and Drainage Design (Institution of Surveyors NSW and Association of Consulting Surveyors NSW),
- Stormwater Register (Association of Hydraulic Services Consultants, Australia),
- Accreditation as a certifier under the Environmental Planning and Assessment Act, 1979 in the relevant discipline, or
- Other designers may be acceptable provided that they can satisfy Council that they have the relevant experience and competence in drainage design.

3.1.3 Stormwater Concept Plans

A concept drainage plan may be accepted for development works where it is clear the site discharges to a preferred drainage point and is generally compliant with Councils requirements.

The Stormwater Concept Plan should include the following:

- Site layout, dimensions and proposed finished floor levels,
- Existing and proposed design contours and/or spot levels,
- Overland flow paths through the site,
- The point of discharge of the drainage system,
- The location and approximate finished levels of drainage pits,

- The configuration of the proposed pipe network,
- The location and extent of any on-site detention storage,
- Cross-section through an OSD/ rainwater system with approximate levels and storage volume (where applicable),
- Any inter-allotment drainage line (where applicable).

The following information should also be included on the stormwater drainage concept plan to ascertain the appropriateness of the proposed system:

- Total site area (m²),
- Contributing and total impervious catchment areas (m²),
- Any contributing pervious catchment areas (m²), and
- A letter granting permission to discharge stormwater runoff into another authority's drainage system. This would include SRA, RMS and Sydney Water channels and various rivers and creeks. The letter should detail any conditions of the approval.

Where it is not clear that the site can be drained in a satisfactory manner to the point shown on the concept plan, the applicant may be required to submit a detailed drainage plan prior to completion of assessment of the Development Application.

Where the simplified method for OSD is used the OSD calculation sheet is to be provided to Council with the Local Development Application.

All development where the site is disturbed must provide Erosion and Sedimentation Control plans in accordance with the requirements of the Department of Water and Energy, the Environment Protection Authority and Council. Soil and Water Management plans shall be prepared in accordance with the Department of Environment and Conservation Guidelines, Landcom's "Managing Urban Stormwater – Soil and Conservation – Volume 1" 4th Edition 2004 (Blue Book) and form part of the engineering drawings.

3.1.4 Detailed Stormwater Plans

Detailed stormwater plans shall be prepared by a suitably qualified engineer and include all of the following additional items (on top of what is listed under concept drainage plans):

- The location of all buildings, driveways, and impervious surfaces,
- The location, trunk diameter and canopy size (drip line) of any significant trees that may have roots that will be affected by the drainage system, whether or not they are on the subject property,
- The location of all downpipes, surface channels, kerbs, pits, pipes, and sub-surface drainage,
- The size and class of all pipes and the size of all pits,
- The invert levels of all pipes and pits,
- The grades of all pipelines,
- Finished surface levels of all pits,
- Finished levels of any catch drains or swales,
- Finished surface levels of paved areas, unpaved areas, buildings and garages,
- Contours of the existing ground levels to Australian Height Datum (AHD),
- The path taken by overland flow during storm events where the capacity of the piped drainage system is exceeded or the system is blocked,
- Cross section details of any swales or catch drains proposed,
- A clear indication of the location of easements; the location, size and depth of any

Council street drainage or inter-allotment drainage pipelines; and the location of any watercourses passing through the property,

- Location of existing buildings or hard paving on the property not being removed as a consequence of the development, and the size and location of all drainage pipes and pits associated with the existing site improvements,
- Details of the connection to Council's drainage system, including a cross-section of the footpath area (where applicable) from where the pipeline leaves the subject site to the point of connection to the street system,
- Special drainage structures eg Headwalls, scour protection shall be detailed,

The detailed drainage plan is to be compatible with the landscape plan approved in conjunction with the development approval. To achieve compatibility the following matters need to be resolved:

- Conflict between the location of drainage pipelines and tree roots is to be minimised. This may be achieved by locating pipelines outside of the drip line of all significant trees,
- There should be no loose landscaping material (especially bark) within any on-site stormwater detention basin, and
- No trees should be planted within any detention basin that will significantly reduce the storage capacity of the basin when the tree grows to maturity.

3.1.5 On-Site Stormwater Detention Plans

Where detention storage is required, the detailed stormwater plans shall include:

- Details of the storage facility,
- The path taken by overland flow during storm events when the capacity of the system is exceeded or the system blocked,
- An elevation showing the outlet control pit including its invert level, surface level and the top water level,
- Details of the basin overflow provisions,
- Details of any orifice outflow control including the plate size, material and thickness, the orifice diameter, the exact location of the orifice on the plate, the exact position of the plate over the outlet pipe, the method for fixing the orifice over the outlet pipe,
- Details of any debris screens including their dimensions, the material used to make to screen, their location, the method for fixing the screen in place,
- The location, size and proposed construction materials and reticulation system of any rainwater tanks,
- Details of the sediment control sump and the means of allowing the sump to drain dry,
- The calculated permitted site discharge (PSD), the storage volume required and the storage volume proposed.
- Where the simplified method for OSD is used the Calculation form On-Site Detention Calculation Sheet in Appendage 12 Section 13 is to be completed and submitted with the application.
- Where the detailed OSD method is used full details of input variables and calculations used for the design of the on-site detention system including the selection of the permitted site discharge, the sizing of storage facility, and the design of the outlet is to be provided.

if below ground storage is proposed details shall also include:

- The location and size of the facility,
- Detailed information about the facility including the dimensions of the structure, the floor level, the slope on the floor, the level of the roof, the top water level, the surface level of any access man-holes, the invert level of all inlet pipes, the invert level and diameter of the outlet pipe,
- Full construction details of the tank or facility, certified by a practising structural engineer as being able to withstand all likely service loads. The details shall include wall, floor and roof slab thickness, reinforcement details, footing details and details of all pit openings.

If above ground storage is proposed details shall also include:

- Sufficient details of finished ground levels within the basin to enable an accurate check of the storage volume provided.

3.1.6 Hydraulic Grade Line Analysis

Where a hydraulic grade line analysis is required a detailed longitudinal section of every pipeline shall be prepared showing:

- The existing ground surface (dotted line),
- The final or proposed surface (full line),
- The pipe size, type, class, joint type and backfill type with a structure number to correspond with the plans and pipeline changes,
- Pipe inverts and grade,
- Flow rates and hydraulic grade lines,
- Pit types and pit 'k' values

3.1.7 Scales and Dimensions

The following scales shall be used for the following plans and sections, unless varied by Council:

- | | |
|----------------------------------|--------------------------------------------------|
| • Engineering Detail Plan | 1:1000, 1:500 or 1:200, |
| • Longitudinal Sections | 1:100 (vertical) to 1:200 or 1:500 (horizontal), |
| • Cross Sections | 1:100 (vertical) to 1:200 or 1:500 (horizontal), |
| • Layout Plan | 1:500, 1:1000, 1:2000 or 1:4000, |
| • Catchment Plan
(catchments) | 1:500, 1:1000, 1:2000 or 1:4000 (for external |
| • Locality Plan | 1:500, 1:1000, 1:2000 or 1:4000, and |
| • Details | 1:10, 1:20, 1:50 or 1:100 as required. |

Linear dimensions on all engineering plans shall be in metres, with the exception of detail plans which may be in millimetres. Methods of dimensioning will be in accordance with the current Australian Standard.

Chainage shall be expressed to the nearest 0.01m, levels shall be reduced to Australian Height Datum (AHD) and expressed to the nearest 0.01m (except Bench Marks, PM's and SSM's which will be expressed to the nearest 0.001m).

3.1.8 Drainage Easements

Where it is proposed to discharge collected stormwater runoff to an existing inter-allotment drainage easement the applicant shall submit to Council information from the Land Titles Office that indicates the subject property has the right to use the inter-allotment drainage system. This information must be received before Council will issue a Local Development Consent for the proposed development. Hydraulic calculations must also be submitted to indicate the capacity of the pipeline and the ability to accept any additional flow. If the pipeline has insufficient capacity it will need to be upgraded.

Where an inter-allotment drainage easement is to be created and the applicant has come to an agreement with the effected property owner, the drainage easement should be registered prior to development consent. Should the negotiation for the easement be continuing or an applicant will pursue the matter through the courts, Council may consider granting development consent with a deferred commencement condition specifying the easement is to be registered prior to the activation of the consent.

3.1.9 Computer Models

Where computer modelling is used for either hydrological or hydraulic analysis, an electronic copy of the input and output files shall be submitted to Council in a form compatible with Council's computer software along with the plans and a hard copy of the input and output data.

Council encourages the use of computer models by Professional Civil Engineers for drainage design. Data input and output files of any program used shall be submitted in electronic format to Council. Council is familiar with the following commercially available programs and recommends their use subject to the comments below. Should Consultants wish to use a program not listed below, then all costs incurred by Council, associated with the independent assessment of the submitted drainage modelling, are to be borne by the applicant who is required to make satisfactory prior arrangements with Council for the payment of all expenses incurred by Council in its assessment of the drainage submission.

- ILSAX: Urban drainage catchment model. This model gives very good estimates of flow rates for urban catchments, and is preferred to the Rational Method. It cannot be used for hydraulic design of piped systems or OSD systems, but does give trial pipe sizes for a given gradient.
- DRAINS: Hydrologic and Hydraulic Urban Catchment model. This model gives very good estimates of flow rates for urban catchments, and is preferred to the Rational Method.
- XP-STORM: Hydrologic and hydraulic urban catchment model.
- RAFTS: Runoff routing model for trunk drainage and retention basin design. Flow rates should be checked against those calculated by other methods.
- TUFLOW: two dimensional hydrodynamic flood models
- HEC-RAS: 1-D Steady/unsteady flow calculations. To be used in open channel design and floodplain modelling.
- RORB: Runoff routing and stream flow routing program used to calculate flood hydrographs from rainfall and other channel inputs.
- WBNM: Watershed Bounded Network Model for flood estimation on natural and urban catchments.

3.1.10 Drainage Reports

Drainage Reports are required for significant development works which seek to utilise the existing drainage system on a property. It is critical the report and investigation address the key concern which is assurance that the existing drainage system is capable of accommodating stormwater runoff from the development in accordance with Council's requirements and that it has been constructed and maintained in a serviceable state.

The drainage report should present evidence that a site inspection of the drainage system was undertaken and should include information and calculations demonstrating compliance with Council's requirements.

3.1.11 Work-As-Executed Plans

In order to have a permanent record of construction which incorporates design details that have been varied prior to or during constructions Works-As-Executed Plans shall be lodged to Council following the completion of engineering works of a subdivision or development prepared by a Registered Surveyor or "Persons Qualified" in Section 3.1.2 (Drainage Consultant Qualifications).

Subdivision Certificates (Plan of Subdivision) will not be processed until the Works-As-Executed Plans have been received and verified. The Surveyor responsible for the Plan of Subdivision, or where easements are registered, covering the subdivision/development, shall supply a signed certificate stating that all pipes and associated structures are located wholly within the respective easements.

Where there is a variation from the design the variation shall be shown boxed, in red colour, on plan and longitudinal sections.

Work-As-Executed plans and documentation shall include:

- All works have been completed generally in accordance with the approved plans and specification,
- Any departure from the approved plans,
- Any additional/deleted work,
- The location of conduits, subsoil lines, stub mains and inter-allotment drainage lines,
- Pipeline long sections showing the constructed invert levels of each pipe at each pit/headwall and pipe dimensions at the entrance and exit of all pits (including any inter-allotment pits and pipes),
- Finished surface levels recorded by spot levels across the whole site.
- For minor regrading (i.e. cut or fill < 0.5m deep) spot levels observed and recorded on plans at allotment corners, centre of front and rear boundaries.
- For major site regrading (i.e. cut or fill over 0.5m in depth) recorded by new contours.
- If an above ground storage basin is constructed, a works-as-executed survey of the detention basin will need to be prepared to demonstrate that adequate storage volume has been provided.
- Where plastic drainage modules are used for an underground detention storage tank, photographic evidence of the installation and certification by an engineer or surveyor is required.
- Any part of a subdivision has had the surface level raised by the placement of any fill, other than nominal topsoiling, showing a minimum of that area of the subdivision that has been filled plus a reasonable surrounding area.
- Details of overland flow provisions.
- All other details which have a bearing on the extent of works and their acceptance by Council.

4 HYDROLOGY

4.1 General

A number of methods are available for determining flow rates, run-off volumes and catchment responses. The following commonly used hydrological methods are acceptable to Council:

- *The Rational Method* – This method has been the most commonly used method for drainage design. It provides simple means for the assessment of design peak flow rates (peak discharge). The rational method is not recommended for the design of detention basins or complex developments.
- *Time-Area Run-off Routing, eg. DRAINS* – DRAINS is a computer based model which involves the routing of the time-area relationship developed for the sub-catchments under consideration. It is suitable for use in urban catchments but requires suitably experienced designers to undertake the modelling and calibration with available flow data where possible.
- *RAFTS* – This is a proprietary computer model based upon the Regional Stormwater Model (RSWM). It includes separate routing of impervious and pervious areas; sophisticated loss models; urban run-off modelling and detention basin design; and provision for river basin analysis.

Council has modelled a number of catchments within the City of Ryde and will provide flow rates to consulting engineers where they are available. Where these flow rates have been provided, Council will not accept alternative flow rate values unless it can be demonstrated the modelling procedure used to determine the flow rate is more accurate than Council's model.

Flow hydrographs are to be generated by use of an appropriate runoff routing computer model such as RAFTS or DRAINS, or other approved equivalent models. Urbanised peak flow rates in particular and general shape, timing and volume of hydrographs are to match those for the undeveloped existing or natural catchment as closely as possible for all storm events.

Other hydrological models may be used as long as the requirements of AR&R are met. Council will require the submission of all calculations together with details of all program inputs and outputs.

Where catchments are large and/or higher confidence in the flow rate prediction is necessary, peak flow rates should be determined using one of the above runoff routing computational programs. For input parameters to be used with DRAINS, RAFTS and XPSTORM please refer to Appendix 4.

Please note when using the program DRAINS for modelling above ground detention basins it is preferred that a staged height vs volume is used to specify the detention storage over depth vs. surface area as drains is limited in its capacity to calculate storage volumes.

4.2 Design Average Recurrence Intervals (ARI)

Average Recurrence Interval (ARI) is the long term average number of years between the occurrence of a theoretical design flood as big as, or larger than, the selected storm. For example, storms with an average intensity greater than a 1 year ARI storm will occur on average once every year. A storm with a higher average intensity such as the 100 year ARI storm will occur on average once every 100 years. ARI is another way of expressing the likelihood of occurrence of a storm.

ARI is an alternative to AEP (Annual Exceedance Probability) to express the likelihood of occurrence of a flood event. For example a 1 in 100 year ARI storm event is the same as a 100yr ARI storm event (it has a 1 in 100 probable chance of occurring). Please note that design storms are based on statistical probability, for example even though a 1 in 100yr ARI storm event has a 1% chance of occurring it is possible that a storm event in the magnitude of a 1 in 100 year ARI event can occur more than once in one hundred years.

Design ARI storm events are used to quantify flow rates and volumes for use in the design of stormwater management of developments. The following **Error! Reference source not found.** specifies design ARI storm events to be used in the design of stormwater systems for developments in the City of Ryde.

Drainage Item	Design ARI storm event
Piped Road drainage (minor system generally longitudinally):	
Urban Residential	20 year
Commercial	20 year
Industrial	20 year
Road drainage (major system) for all types of development:	100 year
Road Crossings (minor system with unobstructed floodway):	
Local/Collector	20 year
Sub-Arterial	20 year
Arterial	100 year
Access to Emergency Facilities	100 year
Road Crossings (major system) for all types of development:	100 year
Piped inter-allotment drainage (minor system):	
Urban Residential	20 year
Commercial	100 year

Industrial	100 year
Flows along an unstable watercourse	5 year
Outflows into unstable watercourse	20 year
Major system (overland flow paths) for all types of development	100 year
Onsite detention systems	5, 20 and 100 year

Table 4.1 Design ARI storm events.

Longer recurrence interval design storms than that specified in **Error! Reference source not found.** above may need to be used in instances where the level of danger to persons or risk of significant property damage warrants such an approach. This would include most developments adjacent to major water courses (flow > 20m³/s for the 100 year ARI storm event). Under some circumstances the PMF will also need to be considered.

4.3 Rational Method

Use of the rational method for determining flow rates will be acceptable where the catchment is relatively small (less than 15,000m² or 1.5ha), has fairly common characteristics and the level of accuracy (sensitivity) of the results is not critical. Where the catchments are large (>15,000m²) and/or a reasonably accurate level of flow rate prediction is necessary, peak flow rates should be determined using a recognised runoff routing computer model such as; RAFTS, WBNM and DRAINS.

If the rational method is used, it is necessary to define the catchment area, sketching its boundaries on a plan and measuring the area in accordance with Section 4.7. The longest flow path to the catchment outlet is established to determine the time of concentration in accordance with Section 4.4. The rainfall intensity for a storm duration equal to the time of concentration (t_c) is selected for a duration equal to the time of concentration of the catchment.

Discharge rates (flow rates) may then be calculated using the Rational Method formula:

$$Q = C \times I \times A / 360 \quad (\text{m}^3/\text{s})$$

Where Q is the discharge flow rate in m³/s,

C is the runoff coefficient value calculated for each different land use type,

I is the rainfall intensity (mm/hr) for a given design ARI and total flow travel time, and

A is the catchment area in hectares (ha).

In urban catchments, it is probable that a greater flow rate may be obtained by applying the Rational Method to a lower part of the catchment with a time of concentration less than the full area travel time. These partial area effects and flows commonly occur when large paved areas are directly connected to the pipe inlet, and the sub catchment discharge is based on a larger pervious area. Similarly, partial area effects can also occur, where a large open space catchment contributes to an urban catchment, with a Time of Concentration substantially different to the urban catchment.

In areas where this may be critical, such as industrial, high density residential development or large scale developments, a partial area check, based on times of concentration of impervious areas directly connected to the pipe system, is necessary. However, for urban drainage design this may not be appropriate and a computer based time-area run-off routing model eg. DRAINS is required. Technical Note 6 (page 24) of Book 8 of AR&R details a worked example for rationale method calculations.

4.4 Time of Concentration

The time of concentration (t_c) of a catchment is defined as the time required for the stormwater run-off to flow from the most remote part (relative to time) of the catchment to its outlet.

In determining the time of concentration for the post development scenario, the designer should assume that the catchments under construction are fully developed in accordance with the land use shown on the relevant Zoning Maps.

In a typical urban drainage system a designer will need to calculate the time of concentration for inlet location and pipe sizing. Regardless of the purpose of the time of concentration calculation, it will include one or a number of the following components:

- Overland or 'sheet' flow time.
- Roof to drainage system flow time.
- Gutter or channel flow time.
- Pipe flow time.

Where the flow path is through areas having different flow characteristics, the flow time of each portion of the flow path shall be calculated separately.

Time of concentration for small catchments under 1ha shall be determined using the Kinematic Wave Equation,

$$t = \frac{6.94(L \cdot n^*)^{0.6}}{I^{0.4} \cdot S^{0.3}}$$

Where t (t_c) is the time of concentration in minutes,

L is the flow path length in metres - being the longest flow path to the catchment outlet,

n^* is the surface roughness/retardance coefficient,

I is the rainfall intensity (mm/hr), and

S is the slope (m/m).

The Kinematic Wave equation is very sensitive to slope and the Retardance Coefficient " n^* ", these should be estimated carefully. Recommended Retardance Coefficients are listed in AR&R and in the following Table 4.2 below.

Surface Type	Roughness Coefficient n^*
Concrete or Asphalt	0.010 – 0.015
Bare Sand	0.01 – 0.016

Gravelled Surface	0.012 – 0.030
Bare Clay-Loam Soil (eroded)	0.012 – 0.033
Lawn	0.030 – 0.040
Sparse Vegetation	0.053 – 0.130
Short Grass Prairie	0.10 – 0.20
Bushland with light undergrowth	0.10 – 0.12
Bushland with heavy undergrowth	0.14 – 0.16

Table 4.2: Roughness Coefficient n*

The minimum time of concentration should not be less than 5 minutes for the total flow travel time from any catchment to its point of entry into the drainage network. The maximum time of concentration in urban areas shall be 20 minutes unless sufficient evidence is provided to justify a greater time. For rural catchments and catchments over 1ha please refer to the procedures outlined in AR&R for time of concentration calculations.

Please note that engineering judgement is to be used when approximating time of concentration values to be used with computational programs such as DRAINS.

4.5 Rainfall Intensities

The Design Intensity-Frequency-Duration (IFD) Rainfall is required as input to the hydrological calculations used for the drainage design.

Appendix 7 provides a catchment map for the City of Ryde.

Alternatively, the IFD Rainfall for the catchment under consideration may be derived in accordance with the current edition of Australian Rainfall and Run-off (AR&R) using IFD program software with raw data from the Bureau of Meteorology. Where values outside of Council's IFD data is used calculations shall be submitted to Council.

4.6 Run-off Coefficient

The coefficient of run-off (*C*) is the coefficient used in the Rational Method and is the ratio of the peak rate of run-off to the average rainfall intensity during the critical rainfall period for the catchment area under consideration. The value of *C* is a statistical composite not only for the infiltration and other losses, but also the effects of channel storage and initial loss.

The coefficient of run-off adopted shall account for the future development of the catchment in accordance with the land use shown on the relevant Zoning Maps. Fraction impervious values shown in Table 4.3 are to be adopted for the various zoning areas in the City of Ryde LGA. Values outside of those specified in the table below can be used if justified with a detailed catchment plan clearly identifying pervious and impervious areas.

Zoning	Example of Land Use	Impervious Fraction (%)

General Residential (R1)	Attached dwellings, residential flat buildings, multi dwelling housing	65
Low Density residential (R2)	Low density housing	65
Medium Density Residential (R3)	Medium density housing	80
High Density Residential (R4)	High density housing	Site Specific (measure)
Neighbourhood centre (B1)	Child care centres, community facilities	70
Commercial Core (B3)	Commercial premises, Function centres, hotel or motel accommodation	100
Mixed Use (B4)	Educational establishments, registered clubs	Site Specific (measure)
Business Development (B5)	Bulky goods premises, industrial retail outlets	100
Business Park (B7)	Office premises, restaurants or cafes	90
Light Industrial (IN2)	Brothels, vehicle repair stations, warehouse centres	90
Special Activities (SP1)	Recreational facilities	Site Specific (measure)
Infrastructure (SP2)	Roads	90
Public Recreation (RE1)	Environmental facilities, kiosks	Site Specific (measure)
Private Recreation (RE2)	Roads, Water recycling facilities	Site Specific (measure)
National Parks and Nature Reserves (E1)	National Parks and reserves	5
Environmental Conservation (E2)	Environmental facilities	Site Specific (measure)

Table 4.3: Fraction Impervious Values

Runoff Coefficients "C" shall be determined in accordance with Section 1.5.5(iii) (pages 18-19) of Book 8 of AR&R. The following equations apply for City of Ryde:

$$C_Y = F_Y \times C_{10}$$

where: $C_{10} = 0.9 \times f + C_{10}^1 \times (1 - f)$ and

$$C_{10}^1 = 0.1 + 0.0133 \times (I_{10} - 25)$$

Where C_y is the Runoff Coefficient for recurrence interval "y" (years),

C_{10} is the 10 year ARI Runoff Coefficient,

C_{10}^1 is the pervious area runoff coefficient,

$^{10}I_1$ is the 10 year ARI, 1 hour duration rainfall intensity,

F_y is the Frequency Factor - See Table 4.4 below, and

f is the Fraction Impervious (i.e. 60% impervious is a fraction of 0.6)- See Table 4.3 for recommended values.

Recurrence Interval	F _y
1	0.8
2	0.85
5	0.95
10	1.00
20	1.05
50	1.15
100	1.20

Table 4.4: Frequency Factors for Runoff Coefficients

Runoff coefficients shall be estimated separately for each land use.

Alternatively runoff coefficients in Table 4.5 can be used for various impervious fractions.

ARI	Fraction Impervious										
	0	0.1	0.2	0.3	0.4	0.5	0.6	0.7	0.8	0.9	1.0
1	0.41	0.44	0.47	0.50	0.53	0.57	0.60	0.63	0.66	0.69	0.72
2	0.44	0.47	0.50	0.53	0.57	0.60	0.63	0.67	0.70	0.73	0.77
5	0.49	0.52	0.56	0.60	0.63	0.67	0.71	0.74	0.78	0.82	0.86
10	0.51	0.55	0.59	0.63	0.67	0.71	0.75	0.78	0.82	0.86	0.90

20	0.54	0.58	0.62	0.66	0.70	0.74	0.78	0.82	0.86	0.90	0.95
50	0.59	0.63	0.68	0.72	0.77	0.81	0.86	0.90	0.95	0.99	1.04
100	0.62	0.66	0.71	0.76	0.80	0.85	0.89	0.94	0.99	1.03	1.08

Table 4.5: Runoff Coefficients (from AR&R Figure 14.13 and Table 14.6)

NOTE : Typically, a minimum runoff coefficient of 0.7 should be adopted.

4.7 Catchment Area

Catchment areas may be determined from contour plans obtained from a detailed survey of the site. Where no detailed survey is available, 1:4000 orthophoto maps may be used to determine catchment boundaries and areas. Where orthophoto maps or survey information is not available Council may in some instances accept the use of other map imagery such as spatial information from NSW Department of Lands.

The determination of sub-catchments within urban subdivisions requires accurate contour information and a catchment plan shall be provided with the calculations.

The design should take into account realistic future road patterns where the contributing catchment includes areas subject to future development. Consideration must also be made to the existing drainage layout in the catchment to determine the outermost contributing catchment area.

Catchment areas to each pit shall be determined from contour information and proposed property boundaries. A site inspection shall always be made to check the contour information and assess the likelihood of any flow path deviations which may occur as a consequence of existing or proposed developments. Changes to flow paths can occur as a result of the construction of fences, retaining walls, buildings etc. after the construction phase of the subdivision. The impact of these changes shall be considered at the design stage when determining catchment areas.

5 HYDRAULICS

5.1 Aim

The design and construction of a drainage system that provides the following:

- a) A “major/minor” stormwater drainage system as set out in Chapter 14 of AR&R (1998),
- b) A “major” system to provide safe, well-defined overland flow paths for rare and extreme storm
- c) A “minor” system capable of carrying and controlling flows from frequent storm runoff events,
- d) A high level of safety for all users,
- e) Provide convenience and safety for pedestrians and traffic in frequent storms by controlling flows during those storms within defined limits,
- f) To ensure damage to private and public buildings located on land affected by stormwater inundation is minimised,
- g) Acceptable levels of amenity and protection from the impact of stormwater, and
- h) Economy of construction and maintenance.
- i) A system of overland flow paths to provide fail safe protection of buildings on the property and protection to adjoining and downstream properties in the event of pipe blockage or storm events that generate runoff greater than the pipe capacity.

5.2 Minor System Criteria

The minor drainage system shall be capable of controlling flows from frequent run-off events up to and including the ARI's as specified in this Section.

The following requirements shall be provided in the design of minor system drainage:

- a) The water surface level for inlet pits shall be 0.15 metres below the invert of gutter or 0.15 metres below the underside of the lid for junction pits.
- b) System blockages shall be assessed when designing for the minor event, as per Section 5.5.
- c) Kerb and gutter shall be provided on both sides of all roads except where the relevant Development Control Plan advises otherwise.
- d) Kerb inlets shall be provided at locations such that the flow in the gutter generally does not exceed 1.5m in any location.
- e) Inter-allotment drainage shall be provided at the lowest point of all allotments together with the creation of an easement over all downstream pipework to the legal point of discharge.
- f) Full piped drainage from all kerb inlets and other inlets shall be provided to the boundary of the subdivision, or approved point of discharge, unless otherwise approved by the Manager.
- g) Bypass from any pit on grade shall not exceed 15% of the total gutter flow at the pit (full capture desirable).

The widths mentioned above shall be measured from invert of the kerb and gutter.

5.3 Major System Criteria

Many of the flooding problems in older areas occur due to inadequate provision of overland flow paths. Thus, all urban drainage designs shall incorporate an assessment of major system flows.

The major drainage system in the form of overland flow paths shall be capable of controlling flows which exceed the capacity of the minor drainage system from run-off events up to and including the 100yr ARI storm event. In drainage sensitive areas identified by Council it may be necessary to provide adequate stormwater management controls for events larger than the 100yr ARI. An overland flow system shall be designed to convey waters through the subdivision or development clear of, and with the required freeboard to allotments and buildings.

Please note an overland flow path must be provided for drainage systems even where the 100 year ARI flows can be maintained within the pipe system. This is to ensure that a safe and adequate "Escape route" is achieved for storm events above that of the pipe system design and in case the minor system fails (i.e. if there is a 50% pipe blockage). This route should be a properly sized overland flow path preferably along a road and pathway system.

The Rational Method may be used to estimate major system flows for critical points in the drainage system. An ARI of 100 years shall be used for this and the difference between the minor system flow and the 100 year ARI flow shall be the basis upon which the major system flow path shall be designed.

Roads and pathways will generally form the flow path by which the major system flows are routed, either to the street drainage system or to a low point with sufficient hydraulic capacity to capture the flows. Special consideration shall be given to trapped low points where the overland flow path may divert surcharge into properties. This is especially important when designing "Downhill" cul-de-sac and kerb returns adjacent to a sag vertical curve. In the former case the overland flow path shall incorporate a depressed pathway with reverse crossfall in the footway. In the latter case consideration shall be given to grading the kerb return such that water flows around the return and away before it breaks over the top of kerb at the low point.

Where an overland flow path needs to be accurately determined, the flow path should be modelled using a computer program as listed in Section **Error! Reference source not found.**. The following requirements shall be provided in open channels, roadways, overland flow paths and stormwater surcharge paths:

Generally:

- a) Minor system blockages shall be assessed when designing for the major event, as per Section 5.5.
- b) The product of depth (d) and velocity (V_{ave}) (also known as Vd product) shall be limited to 0.4 m²/s.

Roadways:

- c) Total flow shall be contained within the road reserve,
- d) Flow depths in roadways shall not exceed 100 mm on the high side of residential streets and 75mm on the low side of residential streets and 75mm in commercial areas,
- e) Flow widths shall not exceed 1.0 metres at bus stops, pedestrian ramps and kerb returns,
- f) Flow widths in any location shall not exceed 2.5m,
- g) The Vd product in the kerb and gutter should not exceed 0.6 m²/s (AR&R, 1998) to reduce hazard for pedestrians within the roadway. However, where there is an obvious danger of injury or loss of life, the Vd product shall be limited to 0.4 m²/s.
- h) Where a road is in fill, a freeboard of 100 mm shall be provided between the 100 year flood level and the lowest point in the footpath.

The widths mentioned above shall be measured from invert of the kerb and gutter. Pit capacities shall be calculated using the appropriate blockage factors listed in Section 5.5, and pipe capacities estimated with trial diameters and head levels no greater than 150mm below the surface levels /

invert of kerb (applicable up to the design ARI for the respective pipeline reach). Where the flow widths above are exceeded these flows shall be intercepted with additional kerb inlets. Technical Note 4 (pages 16-17) of Book 8 of AR&R details a method for calculating gutter and road flows.

5.4 Hydraulic Grade Line Analysis

The Hydraulic Grade Line method shall be used for pipeline design for medium to large scale developments and shall generally be carried out in accordance with AR&R (1998). For pipeline design for small residential developments please refer to Section 0.

The detailed hydraulic grade line method is recommended for the analysis of stormwater pipe systems based on an analysis proceeding from downstream to upstream through the system. Calculations shall substantiate the hydraulic grade line adopted for the system and be shown on the drawings. It is not the purpose of this document to give a detailed explanation of the method, but important points are mentioned below. Pipes/culverts shall be determined using Colebrook-White formula with the recommended coefficients referred to in Table 5.1 below.

Pipe Material	Recommended K value (mm)
Unplasticised polyvinyl chloride (uPVC)	0.03
Vitrified clay pipe (VCP)	0.04
Rectangular hollow section (RHS)	0.046
Fibre reinforced concrete (FRC)	0.06
Reinforced concrete pipe (RCP)	0.3

Table 5.1: Roughness Coefficients (K)

Appendage 6 in Section 8 contains a discharge and velocity graph for circular pipes running full but not under head with Colebrook-White formula $k = 0.06$. The tail water level to be adopted in the hydraulic grade line analysis will depend on the outflow conditions. The following values listed in Table 5.2 may be used when conducting a hydraulic grade line analysis where the downstream starting water level (tail water level) is unknown.

Outfall/Outlet Condition	Tail water Level
Discharge to kerb and gutter	For 5yr ARI adopt 150mm below kerb invert, 20yr ARI adopt kerb invert and 100yr ARI adopt top of kerb level
Discharge to an existing pit in street	The inlet pipe obvert in the downstream pit

Free outfall	Adopt the pipe obvert
Discharge into receiving waters	Adopt tail water equivalent to the design ARI flood level of the system
Open Channel	The pipe obvert for the minor storm event and the top channel wall or embankment level for the major event where the flood level is unknown.
Surcharge point/pit	Adopt tail water level equivalent to the height of surcharge (ponded height)

Table 5.2: Tail water Level Conditions

Where determination of a tail water level is in doubt please consult with Council's Engineers before undertaking the design. Values outside that specified in the table above may only be used if sufficient justification is provided with accompanying detailed calculations.

Pit loss factors (k) for pits, slope junctions, bends, transition structures, inlets and outlets shall be calculated using Missouri Charts or Hare equations. Where these do not apply an appropriate value is to be selected. The top pit in the system must have sufficient depth to generate sufficient head to charge the pipe system. This can be calculated by using coefficients derived from the Missouri Charts. A k value of 3.5 - 4.5 should not automatically be assigned to all starter pits, each pit should be assessed on its merits. Computer program default pressure change coefficients shall not be acceptable unless they are consistent with those from the recommended charts. The chart used and relevant coefficient for determining k factors shall be noted on the hydraulic summary sheet or design report. An absolute minimum k factor of 0.3 is to be used for all pits.

Pit loss factors for drop pits shall be calculated in accordance with the charts previously mentioned. An allowance shall be made relative to the drop through the pit. When the obvert of the outlet pipe is at or greater than $D_o/4$ below the invert of the upstream pipe, the inflow shall be regarded as grate flow. That is, when the obvert of the outlet pipe is $1/4$ of its diameter or greater, below the invert of the upstream pipe then the pipe loss factor (k) shall be no less than 4.5. Intermediate cases may be determined by linear interpolation of pit loss factor (k) up to 4.5. Because of the high losses in these pits, it may be preferable to design a mitre bend or a steeper section of pipe.

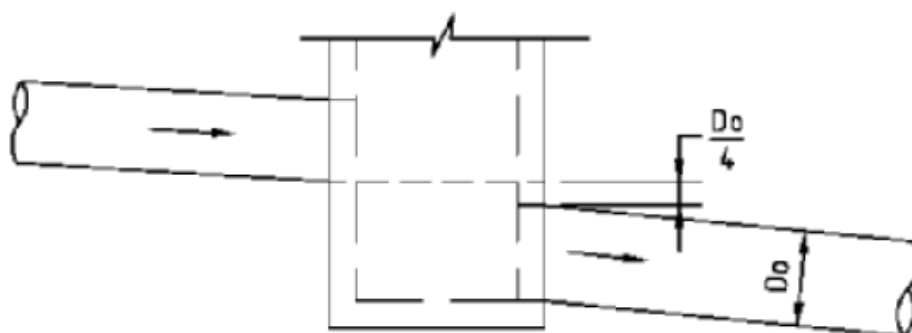

An allowance of 150mm shall be adopted below the lowest point of the pit inlet/kerb invert, to allow such inlets to act efficiently. Where this cannot be achieved it will be necessary to obtain the concurrence of Council before proceeding. Where pipes are operating under head it is recommended that the procedures in Technical Note 9 Book 8 (pages 42-45) of AR&R detail are used.

Hydraulic losses for entry and exit of channel systems, culverts, headwalls and other structures shall be in accordance with the Australian standards or other similar recognised texts.

5.5 Pit Requirements

Once the sub catchment flows are known, pit inlets can be designed in accordance with the charts contained in Appendages 7 to 12 in Section 8. Inlet pits shall be installed at depressions and other locations to permit the entry of water to a stormwater drain and must have a flush fitting grate.

Surface inlet pits shall be sufficiently large to accept the predicted flow.

All new pit inlets shall be constructed using welded steel ("Weldlok") type or equivalent grates with appropriate skirts. On grade, percentage capture by grates is mainly dependent on lintel size, tests show that the two types of grates mentioned above have similar performance characteristics on grade when in combination with a lintel.

The charts for the sag inlets are based on tests conducted by the RTA N.S.W., Water Research Laboratory and the West Australian Institute of Technology and incorporate the following blockage factors:

- (a) 10% reduction in capacity for clogging of the kerb inlet.
- (b) 30% reduction in capacity for clogging of the grating.
- (c) 50% reduction in capacity for all sag pits.

Alternatively inlet capacities can be calculated from first principles using formulas as detailed in AR&R. If using these formulae the following blocking factors shall be applied,

Condition	Pit Type	Theoretical capacity allowed	i.e. % blocked
Continuous grade	Kerb inlet pit	90%	10%
Sag	Kerb sag pit	80%	20%
Surface inlet pit cover (grating)	Surface inlet pit	70%	30%
Surface inlet pit cover (grating) with legs (letterbox)	Surface inlet pit	50%	50%

Where it is proposed to use a grate not conforming to these requirements, it is necessary to submit a detailed investigation from an accredited laboratory establishing the performance of the grate prior to it being accepted or rejected by Council.

Computer analyses shall generally conform to the inlet capacities graphed on Appendages 7 to 11 in Section 8, unless prior approval has been received from Council.

Ponding depths can be calculated using design charts, Appendages 7 to 11 in Section 8. Lintel sizes shall be commensurate with inflow requirements.

A nominal internal lintel size of 0.9m shall be placed on junction pits along kerb and gutter in public roads. The minimum nominal internal lintel size for grated gully pits in public roads shall be 1.8m, unless the pit's main function is to facilitate a change in direction or grade of the stormwater pipe, in which case the nominal internal lintel size may be reduced to 1.2m. The minimum nominal internal lintel size for grated gully pits in "sags" shall be 2.4m.

An assessment of the topography will determine the location of proposed drainage paths. Once the location of a proposed network is defined, trial pit locations should be arranged. Generally, pits should be spaced with minimal bypass flows. An approximate procedure for locating pits is detailed in "Technical Note 2" in Book 8 (page 11) of AR&R. Pits should be located at junctions; kerb returns; sag points; and changes in grade, level, direction, pipe size or pipe class. Kerb inlet pits shall be located so that the gutter flow width is in accordance with the requirements of minor and major system criteria and at a maximum spacing of 60 metres where flow widths are not critical.

The following general items shall be adhered to in the design of pits:

- a) Non-standard drainage structures for pipes larger than 750mm diameter shall be designed and certified by a Competent Structural Engineer by way of an accompanying letter or by statement on the engineering plans.
- b) All drainage structures deeper than 1.8m shall be reinforced with appropriate Fabric to Engineer's (structural) requirement and pits deeper than 3.0m shall be structurally designed and certified.
- c) Drainage pits shall be designed wherever possible such that the inlet and outlet walls are perpendicular to the centreline of inlet and outlet pipes.
- d) Wherever possible, drainage pits shall be designed so that the pipe centrelines intersect on the downstream pit face.
- e) The base of the pit should be at the same level as the invert of the outlet pipe (unless a sump pit). Where this has not been achieved the pit floor is to be benched with concrete. Rainwater is not permitted to pond within the stormwater system.
- f) The grated covers of pits larger than 600 x 600mm are to be hinged to prevent the grate from falling into the pit.
- g) Drainage pits shall be designed and constructed in accordance with Section 8.5 (Public Civil Works).
- h) Provide step irons for all pits deeper than 1200mm. The step irons shall be staggered to give a 300mm spacing vertically and 220mm spacing horizontally. The type of step irons used must satisfy Council's requirements for durability and strength.
- i) A pit shall be provided at the road boundary at the lowest point of the system before the drainage line enters public roads and footways. These pits may be either "precast" or cast "in-situ" concrete pits, PVC or similar "precast" pits are not acceptable. Where there is an OSD system this pit shall be a minimum 450 x 450. In the case of drainage systems that do not have an on-site detention system, this pit must be a minimum of 600mm x 600mm and contain a debris screen. For details of the debris screen refer to Section 1.4.7.
- j) Pits shall be designed so that the discharge from inlet pipes is directed towards the outlet pipe.

- k) In medium density residential developments private courtyards must contain at least one pit not less than 300 x 300mm.
- l) All pit grates are to have the same clear opening as the internal plan dimension of the pit (for pits up to 1200 square).
- m) The maximum weight of each individual hinged grate shall be 20 kilograms.
- n) All grates are to be hinged and provided with an appropriate childproof lockdown system. Hinged grates are to be placed away from any wall or kerb, to ensure that the grates can be fully opened for safety reasons.
- o) Where precast pits are proposed in Council's road system, the pit shall be placed on a 75mm thick concrete base and backfilled with concrete to half way up the outside of the unit. *PVC type pits are not acceptable.*
- p) In-situ pits in Council's road system are to be constructed on a concrete bed of at least 150mm thick. The walls are to be designed to meet the minimum requirements of clause 4.6.3 of AS 3500.3 – 1990.
- q) Pits shall be located at least 1 metre away from driveway laybacks.
- r) The minimum pit size for any inlet, gully or junction pit on Council drainage systems is 900 x 900 mm clear internal.
- s) Continuous trench drains are to be of width no less than 150mm and depth not less than 100mm. The bars of the grating are to be parallel to the direction of the surface flow.
- t) PVC pits will only be permitted if they are not greater size than 450 x 450 mm (maximum depth 450mm) and are heavy duty.
- u) Stormwater pits or cleaning eyes shall be installed at each junction, change in gradient, and change in direction, at a maximum spacing of 30 metres, directly above any reflux valves, orifice plates and debris screens to facilitate maintenance of stormwater pipes.
- v) Minimum pit sizes for various depths (D) shall be in accordance with Table 5.3.

Depth (mm)	Minimum Pit Size (mm)
$300 \geq D$	300 x 300
$600 \geq D > 300$	450 x 450
$900 \geq D > 600$	600 x 600
$1200 \geq D > 900$	900x 900
$D > 1200$	900 x 900 (with step irons)

Table 5.3 :Minimum Pit Sizes

5.6 Pipe and Culvert Requirements

Pipes and culverts shall be designed overall as a gravity system with due regard to the upstream and downstream system to satisfy minor and major design criteria.

For small residential developments draining catchments up to 1000m² (0.1ha) only the following pipe design chart can be used. Figure 5-1 on the following page shows the pipe sizing chart for small residential developments.

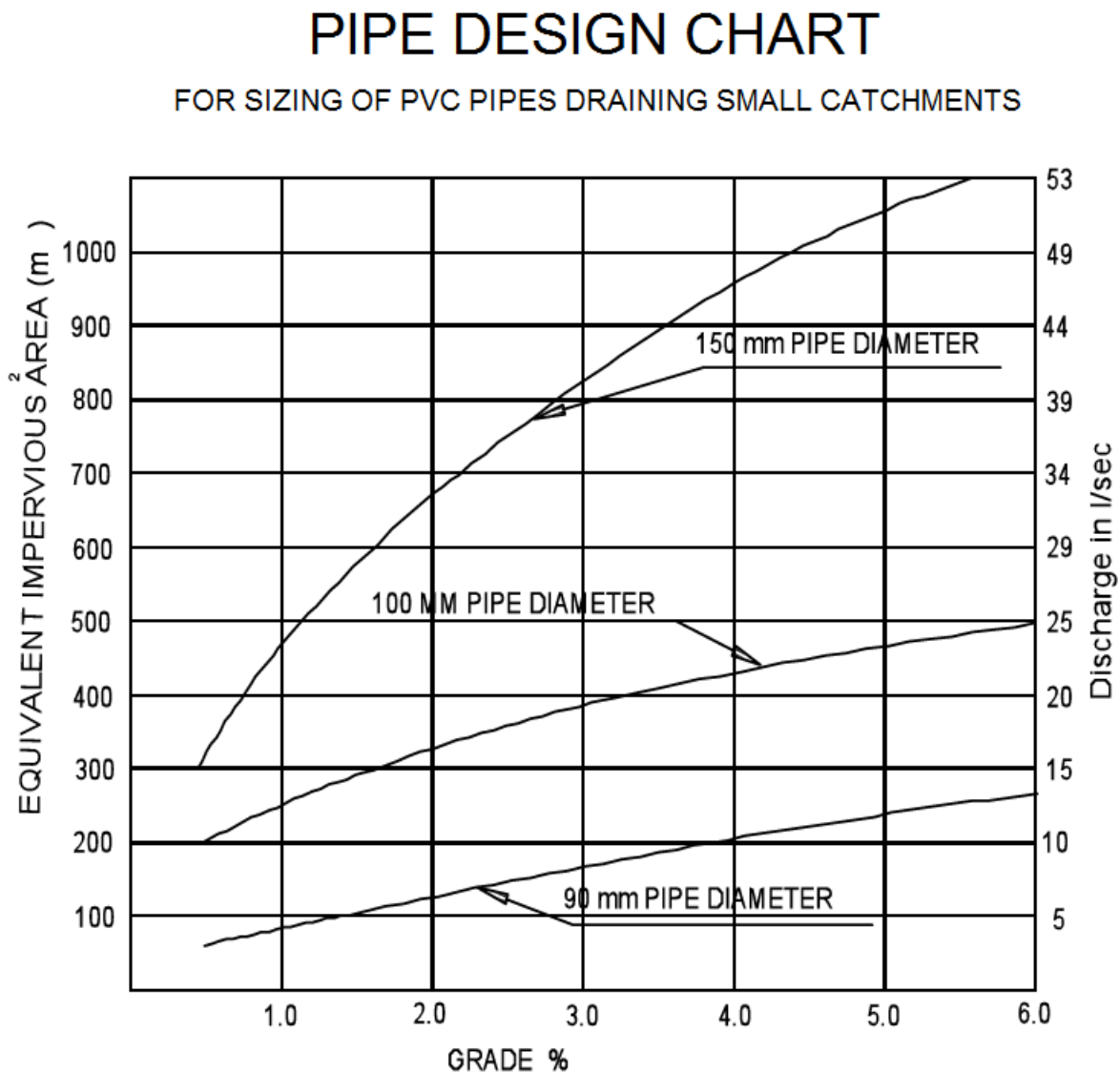

This figure has been prepared using expected rainfall intensities from a 20 year ARI storm event of 5 minutes duration with an intensity of 195mm/hr. The Colebrook-White roughness coefficient is assumed to equal 0.03. The equivalent impervious area for grassed catchments is taken as 0.7 x area.

Figure 5-1 : Pipe Sizing Chart for Small Residential Developments

For larger scale developments with impervious areas larger than 0.1ha where the level of accuracy (sensitivity) is not critical Manning's equation can be used to calculated pipe capacities. For

Manning's equation please refer to Section 5.8.2. Piped road drainage systems must provide a HGL analysis as listed in Section 5.4.

Culverts shall be designed in accordance with culvert hydraulics theory i.e. the culvert capacity is determined by the flow conditions, depending on whether inlet control or outlet control governs. Recommended design procedures are contained in Section 3 of the Concrete Pipe Association of Australia's publication: "Hydraulics of Precast Concrete Conduits - Hydraulic Design Manual".

Pipes and culverts shall be designed in accordance with the following:

- a) The minimum pipe size shall be 375mm diameter (Class 4) in roadways.
- b) The backfill to pipes under roads shall be 5% cement stabilised sand.
- c) Minimum box culvert size in Council property of 600 mm wide by 300 mm high.
- d) In order to provide accessibility for maintenance and repair work, the location of pipes under building structures will only be permitted in exceptional circumstances where there is no other practical solution. Please refer to Section 1.6.
- e) A minimum desirable grade of 1.0 % shall be provided for self-cleansing purposes under low flow velocities for pipes less than 225mm and 0.5% for all larger pipes.
- f) Where pipe grades are in excess of 15%, Concrete Thrust Blocks/anchor blocks shall be placed at the top and bottom of the inclined section and at intervals not exceeding 3.0m. Anchor blocks are to be designed according to clause 3.5.3 of AS3500.3-1990.
- g) Pipe grades >20% are NOT permitted, except where approved by Council in special unavoidable circumstances.
- h) Connection to stormwater drains under buildings shall be carried out in accordance with section 3.10 of AS 3500.3 – 1990.
- i) Above ground pipe work shall be carried out in accordance with Section 6 of AS 3500.3 – 1990.
- j) Pipe velocities shall be between 0.5 m/s and 6.0 m/s and preferably between 1.0 m/s and 5.0 m/s during the design storm to ensure the flow is self-cleansing but not likely to cause scour.
- k) Minimum pipe size shall be 90mm where the line only receives roof water runoff or 100mm where the line receives runoff from paved or unpaved areas on the property.
- l) Minimum pipe cover shall be as follows in Table 5.4.

Pipe	Location	Minimum Cover
PVC and uPVC	Not subject to vehicle loading	100mm single residential
		300mm all other developments
	Subject to Vehicle loading	450mm where not in road
	Under a sealed road	600mm
	Unsealed road	750mm
	Paved Driveway	100mm plus depth of concrete
Concrete		450mm

Table 5.4: Minimum Pipe Cover Requirements

See AS 2032 Installation of UPVC pipes for further information.

Concrete pipe cover shall be in accordance with *AS 3725-1989 Loads on buried concrete pipes*, however a minimum cover of 450 mm will apply. Where insufficient cover is provided, the pipe shall be covered by at least 50 mm thick overlay and shall then be paved with at least:

- 150 mm reinforced concrete where subject to heavy vehicle loading,
- 75 mm thickness of brick or 100 mm of concrete paving where subject to light vehicle traffic, or
- 50 mm thick brick or concrete paving where not subject to vehicle traffic.

5.7 Bridges and Culverts

Bridges and major culverts shall be designed for the major storm event generally without afflux in urban areas. A minimum clearance of 0.3 metres should be provided between the major flow level and the underside of a major structure to allow for passage of storm debris.

5.8 Overland Flow

5.8.1 General

Overland flow paths shall be provided to convey flows in excess of the pipe system and convey flows in the major storm event from a development site to the receiving water body in accordance with the following generally in accordance with Chapter 14 of AR&R (1998) and the current version of *NSW State Government Floodplain Management Manual*.

Overland flow paths (open channels and free surface flow areas) associated with major system flows for OSD systems, road systems, and conveying local upstream catchments where the level of accuracy (sensitivity) is not critical and where uniform flows are occurring, i.e. the channel cross-section, roughness and slope are constant over a reasonable distance; Manning's equation can be used to approximate water depths and velocities.

In areas of shallow inundation (typically less than 0.1 to 0.2m in a 100 year flood) that are distant from major watercourses being impacted by the conveyance of overland flows classified as a 'Local Drainage' area under the Floodplain Development Manual OR where Council deems that there is potential risk of damage and/or injury to persons a computational model must be used to calculate water depths and velocities. Detailed analysis for such cases shall be in accordance with Section 4.

Council will also accept in some circumstances using Manning's equation to determine approximate pipe capacities.

When using Manning's equation to calculate water depths and velocities careful consideration must be made of the upstream and downstream influences. Where uniform flow is occurring, i.e. the channel cross-section, roughness and slope are constant over a reasonable distance; Manning's equation may be applied to the cross-section without consideration of upstream or downstream influences. For most overland flow analysis the assumption of uniform flow will not be appropriate and consideration must be given to upstream and downstream controls, losses for afflux and other hydraulic losses. It is recommended in these instances that a computational model is undertaken in accordance with Section 4 **Error! Reference source not found..**

The depth x velocity product (Vd product) in the kerb and gutter should not exceed 0.6 m²/s (AR&R, 1998) to reduce hazard for pedestrians within the roadway. However, where there is an obvious danger of injury or loss of life, the Vd product shall be limited to 0.4 m²/s.

The Vd product of overland flows in all other cases (across the footpath, within the road reserve, through properties) shall be such that the safety of children and vehicles are considered and restricted to below 0.4 m²/s. In areas where there is heavy pedestrian traffic and children the maximum Vd product shall be in accordance with Table 2.2 Maximum Vd products in areas accessible to children and the elderly. in Section 2.3.1. In all other cases where there is overland flow through a property the Vd product shall be restricted to 0.4 m²/s.

For further information please refer to the current version of the NSW Floodplain Development Manual.

5.8.2 Manning's Equation

Manning's equation is:

$$Q = \frac{1}{n} (AR^{2/3}S^{1/2})$$

Where Q is the discharge flow rate in m³/s,

n is Manning's roughness coefficient,

A is the cross sectional flow area,

R is the hydraulic Radius (m) = A/P

P is the wetted perimeter (m) of the channel/pipe, and

S is the channel/pipe slope (m/m).

Table 5.5 below lists the Manning's roughness coefficient for different surface types to be used.

Surface Type	Mannings “n”
Concrete	0.013
Asphaltic Concrete	0.015
Flush Seal	0.014
Sprayed Seal	0.018
Rough texture surfaces (ie. pavers)	0.018
Gravel	0.02
Bare clay – loam earth	0.022
Lawns	0.05
Short grass	0.06
Long grass	0.1
Natural channel with earth bed	0.04
Natural channel with rock bed	0.045
Natural channel with coarse gravel bed	0.05

Table 5.5: Recommended Manning’s “n” values

Please note that Manning’s roughness coefficient “n” is not the same as the surface roughness/retardance coefficient “n*” used in the kinematic wave equation.

The major flows must have an overland flow path such that all floor levels have minimum freeboards in accordance with Section 0 of this Manual. The freeboard requirement may be varied on consideration of the sensitivity of the floodway parameters to the flows subject to approval by Council.

6 WATERWAYS

6.1 Scope

This section of the Manual sets out Council's requirements for the design and stormwater management of waterways. It is in no way a comprehensive design manual and it is intended to be read in conjunction with current best management practices.

6.2 Aim

The aim of this section is to provide detailed guidelines for managing stormwater flow in Council's waterways and provide guidance for protecting the waterways.

6.3 General

The trunk stormwater system, creeks and groundwater flow within the City of Ryde discharge into the Lane Cove and Parramatta Rivers. These waterways are currently used for recreation and transport, as well as providing flora and fauna habitats with a range of remnant natural ecosystems along their length that require protection. As stormwater flows through a catchment it collects many substances including litter, sediment, nutrients, chemicals, oil and grease, depositing them further downstream. A co-ordinated and integrated approach, including the management of stormwater discharging from specific sites, is required if the quality of stormwater discharging into these waterways is to be of a standard that will not have a detrimental impact upon these waterways as well as maintaining or improving the quality of the natural environment.

The philosophy of this section is to minimise the disturbance due to developments on waterways. In practice this generally involves the design and installation of appropriate devices to treat stormwater before it leaves the subject site where deemed feasible. For requirements pertaining to quality of stormwater at or near the source of potential pollutants please refer to Council's WSUD tools.

6.4 Stability and Runoff Frequency

Urban development increases the frequency, duration, peak flows and volume of stormwater runoff, due to the increase in impervious area in urban catchments. Pipe and constructed channel drainage systems deliver flows more rapidly to receiving waters and concentrate flows at a single point. An important consequence of these effects is the potential for increased erosion of natural waterways downstream of urbanising areas. Waterway stability objectives have been identified to minimise the impact of urban developments of urban development on stream morphology.

6.5 Riparian Zone

The riparian zone must not be subject to development (erection of structures or fill) without the specific consent of Council. The riparian zone consists of 5 metres either side from the top of the bank of a non-perennial watercourse, 20 metres either side from the top of the bank of a perennial watercourse and within the 100 year flood plain (whichever is greater). This must be calculated by a consultant engineer. During the rehabilitation of riparian vegetation, the planting of indigenous native plant species is required when adjacent to bush land. In other areas, locally native species are encouraged, taking into consideration the surrounding landscape and land use. Retaining and restoring natural watercourses achieves the following benefits:

- Stream stabilisation, by reducing the velocity of stormwater, stream bank erosion and sedimentation of waterways.
- Increased water infiltration and groundwater recharge, resulting in a reduction in the amount of stormwater and flooding incidence.
- Improved water quality, because vegetation acts as a filter, reducing pollutant and nutrient levels.

- Improved biological integrity of the watercourse through the provision of a variety of habitats for aquatic organisms and by providing a self-functioning and stable system.
- Provision of habitat and wildlife corridors which can assist in the conservation of biodiversity.
- Improved aesthetic and recreational values.

6.6 Stream Rehabilitation

As part of the site analysis required prior to development consideration must be given to the retention of any existing watercourses, and these should be built around (rather than over or through) as much as possible.

The rehabilitation of degraded watercourses may include removing pipes or concrete lining from channels (subject to DA approval) and replacing them with more 'natural' watercourses.

Many can be constructed to become an attractive natural feature of a property or park. A wide range of techniques can be used, including rock armouring/protection, gabions, rock lined channels creating a series of pools and riffle zones, stilling ponds, drop structures, and sandstone walling. There should not be more than a 3 metre drop between pools. Natural materials, similar to that found in the local area should be used and all gabion structures should be filled with sandstone cobbles rather than basalt. Revegetation of these areas shall be undertaken using local native species.

The methods listed above can be incorporated where new stormwater channels need to be constructed as part of a development, in lieu of the more conventional (and usually more expensive) methods.

A detailed design produced by a qualified stormwater engineer must be completed for all open channel constructions and approved by Council before works are undertaken.

During construction, soil and vegetation disturbance should be minimised, by restricting machinery access, using experienced machine operators, and installing and maintaining effective sediment and erosion control measures in accordance with Section 7.

When a more natural stream environment is established and the diversity of aquatic organisms is high, the number of mosquitoes are kept to a minimum as they become part of the natural system and become the prey of aquatic fauna, such as frogs.

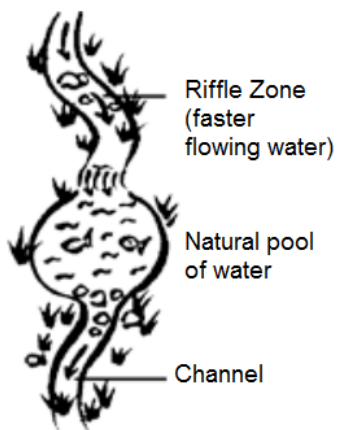

NATURAL WATERCOURSE
(RETAIN/REHABILITATE)

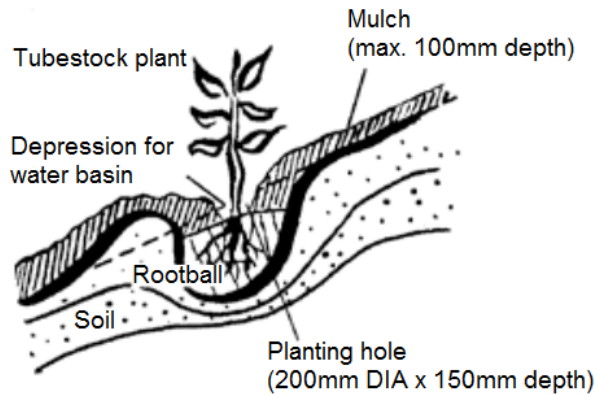

PLANTING FOR RIPARIAN VEGETATION

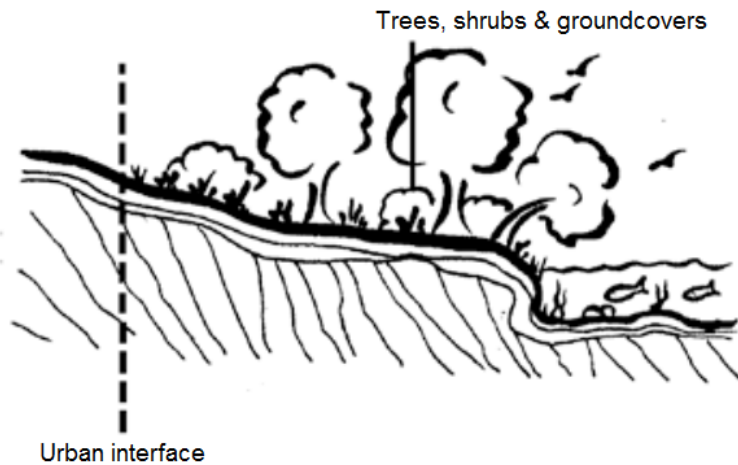

RIPARIAN VEGETATION (RETAIN/REPLANT)

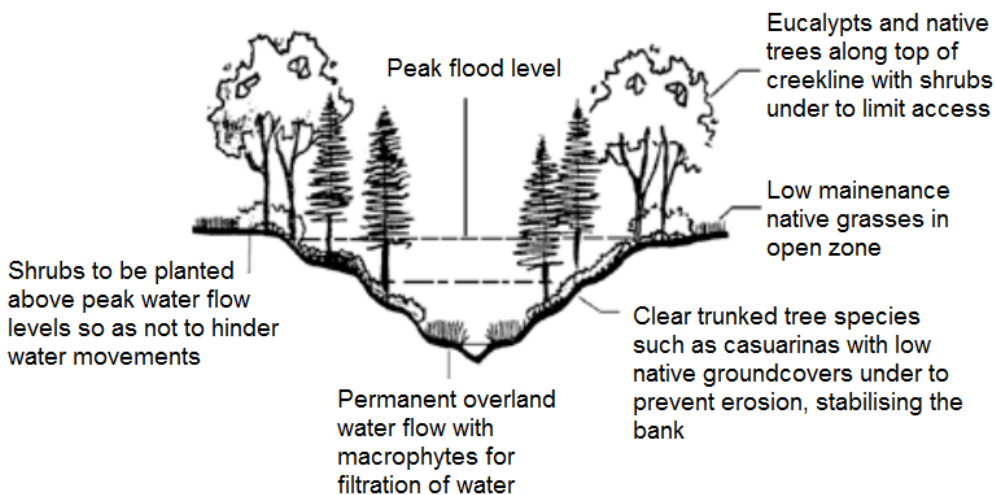

RIPARIAN VEGETATION (RETAIN/REPLANT)

On the

following page shows some examples of riparian systems.

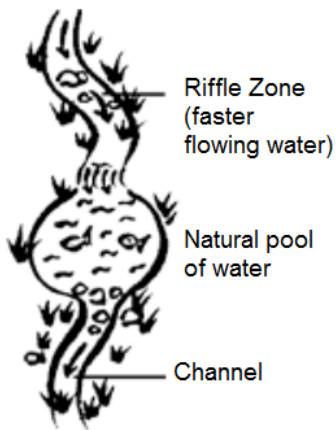

NATURAL WATERCOURSE
(RETAIN/REHABILITATE)

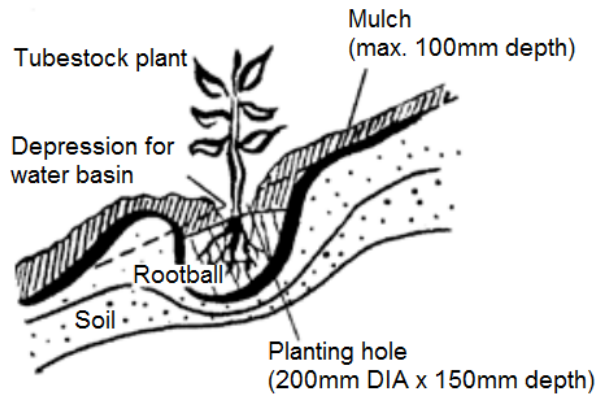

PLANTING FOR RIPARIAN VEGETATION

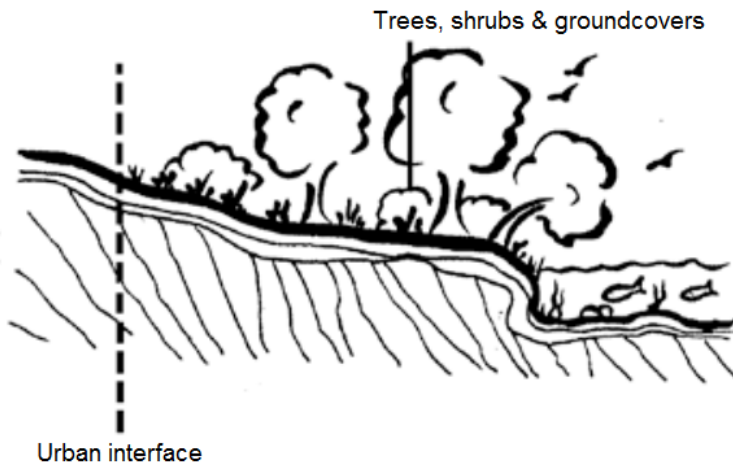

RIPARIAN VEGETATION (RETAIN/REPLANT)

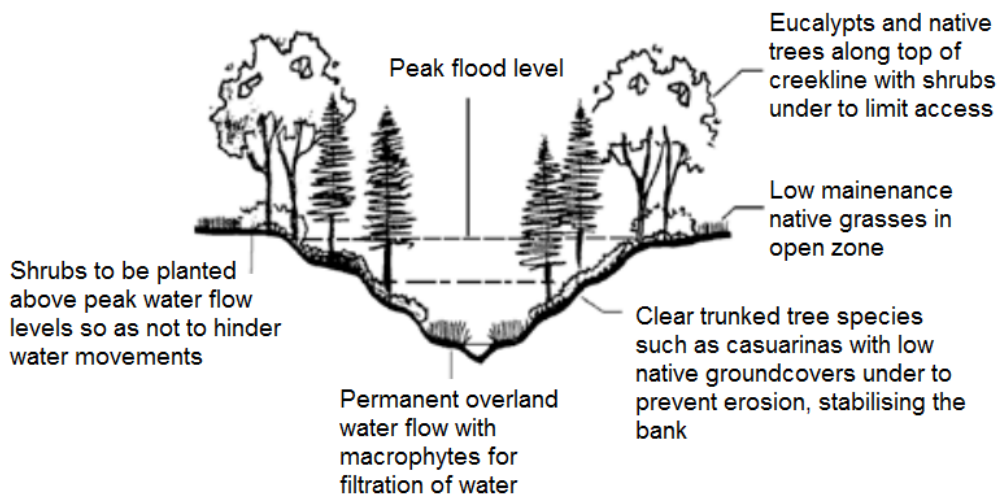

RIPARIAN VEGETATION (RETAIN/REPLANT)

Figure 6-1: Examples of Riparian Systems

6.7 Riparian Vegetation Management

Any existing native vegetation along a natural watercourse should be retained within the riparian zone during the development of a site and should be considered in the initial design stages.

Riparian vegetation should be protected by fencing to avoid damage from machines during development. If any noxious, environmental and nuisance weeds are present these should also be removed.

If there is little or no riparian vegetation remaining it should be re-established within the riparian zone. This rehabilitation of riparian vegetation will involve one or more of the following activities:

- Weed removal;
- Soil stabilisation;
- Erosion and sediment control measures;
- Planting and mulching; and
- On-going maintenance.

Sufficient on-going weed management at the site will be required until the indigenous vegetation is established. This is usually required for a minimum of 3 years. This maintenance must be included in the overall costs of the project and be detailed in a plan of the proposed works that must be approved by Council prior to commencement.

If weeds are playing a significant role in bank stabilisation, gradual removal should be undertaken whilst the desired species regenerate, to limit soil loss and erosion. Herbicides and pesticides should not be sprayed within 20 metres of waterways.

Where native riparian vegetation is to be rehabilitated, professionals with qualifications and experience in bush regeneration techniques should be employed and local indigenous species planted. These plants should be propagated from local seed stock.

Existing sites with similar conditions nearby containing natural riparian vegetation can be studied to obtain a list of appropriate indigenous plant species.

Shrubs

- *Lomatia myricoides*- Long-leaved Lomatia
- *Viminaria juncea* -Native Broom
- *Callistemon citrinus* -Red Bottlebrush
- *Callistemon linearis* -Narrow-leaved Bottlebrush
- *Melaleuca ericifolia* – Swamp Paperbark
- *Bauera rubioides* -Dog Rose
- *Austromyrtus tenuifolia* -Narrow-leaf Myrtle
- *Baeckia linifolia* -Swamp baechea
- *Tristania neriifolia* -Water Gum

Grasses and Groundcovers

- *Cyperus* spp.
- *Lomandra longifolia*
- *Adiantum aethiopicum*
- *Centella asiatica*
- *Commelina cyania*
- *Baumea* spp

- *Dichondra repens*
- *Juncus kranzii*
- *Sarcocornia quinqueflora*
- *Hydrocotyle* spp.
- *Lepidosperma* spp.
- *Oplismenus imbellicus*
- *Restio fastigiatus*
- *Viola hederacea* – Native violet

Ferns

- *Blenchnum cartilagineum*
- *Blenchnum nudum*
- *Christella dentate*
- *Todea barbara*
- *Pennisetum alopecuroides*
- *Dnthonia linkii*
- *Poa labillardieri*

Aquatic Plants

- *Phragmites australis*
- *Gahnia melanocarpa*
- *Gahnia sieberana*
- *Juncus usitatu*
- *Carex appressa*
- *Isolepis nodosa*
- *Triglochin procera*
- *Philydrum lanuginosum*
- *Eleocharis sphacelata*
- *Alisma plantago-aquatica*
- *Bolboschoenus fluviatis*
- *Schoenoplectus mucronatus*

7 SOIL AND WATER MANAGEMENT

7.1 Scope

This section of the Manual sets out Council's requirements for erosion and sediment control. It is in no way a comprehensive design manual and it is intended to be read in conjunction with the *Department of Environment and Conservation Guidelines, Landcom's "Managing Urban Stormwater – Soil and Conservation – Volume 1" 4th Edition 2004 (Blue Book)* and other similar recognised texts.

7.2 Aim

The aim of this section is to provide detailed guidelines for managing erosion and sediment control during the construction of developments in the City of Ryde.

7.3 General

All developments, where the site is disturbed, shall provide appropriate Erosion and Sedimentation Control measures to control runoff, mitigate soil erosion and trap pollutants before they can reach downslope lands and receiving watercourses. This is to ensure that downstream properties, Council's drainage system, natural watercourses and bushland area are protected from the adverse effects of sediment and other pollutants.

Where required, sediment ponds together with treatment trains are to be implemented on all relevant construction sites. For sites smaller than 250m² a small works sediment control plan is required to be submitted, while for sites with disturbances of between 250m² to 2500m² an Erosion Sediment Control Plan (ESCP) is required. For sites larger than 2500m² a Soil and Water Management Plan (SWMP) is required.

A small works sediment control plan will need to detail simple erosion and sediment control measures required such as silt fencing, hay bales and sand bags. Explanatory notes are to be included on the plans advising that sediment deposition on roads and into receiving waters is to be avoided.

ESCP's and SWMP's shall be designed and constructed in accordance with Landcom's "Managing Urban Stormwater – Soil and Conservation – Volume 1" 4th Edition 2004 (Blue Book).

8 APPENDAGES

1. Council's Std. Drawing of connections to Kerb and R.C pipe
2. Absorption Calculation Sheet
3. On-Site Detention Calculation Sheet
4. Ryde Catchment Map
5. Orifice sized according to depth of ponding and PSD
6. DRAINS, RAFTS and XPSTORM Input Parameters
7. IFD Data
8. Discharge and Velocity Graph
9. Pit Inlet Design: Grated Kerb Inlet – Independent of grade
10. Pit Inlet Design: Kerb Inlets in Sags
11. Pit Inlet Design: Inlets Capacities for Gratings in Sags
12. Pit Inlet Design: Inlets Capacities for Kerb Inlets with Duram Type Grates in Sags
13. Pit Inlet Design: Inlets Capacities for Kerb Inlets with WELDLOC Type Grates in Sags
14. Example Easement Letter

8.1 Appendix 1: Council's Std. Drawing of connections to Kerb and R.C pipe

CONNECTION WITH 150 MM CONCRETE KERB

1. INTERNAL DIAMETER OF PIPES OR INTERNAL HEIGHT OF RECTANGULAR SECTION ACROSS THE FOOTPATH SHALL BE 100 MM MAXIMUM, 90 MM MINIMUM.
2. PIPES ACROSS FOOTPATH SHALL BE SEWER GRATE U.P.V.C.
3. RECTANGULAR SECTIONS ACROSS FOOTPATH SHALL BE CAST IRON OR HOT DIP GALVANISED R.H.S.
4. CONVERT 150 MM DIAMETER PIPES WITHIN THE PROPERTY TO A 200 X 100 X 6 MM GALVANISED R.H.S. ACROSS THE FOOTPATH, USING A 300 X 300 PIT WITH A REMOVABLE LID.
5. CONNECTIONS TO KERB ACROSS THE FOOTPATHS TO BE AT A MAXIMUM OF 60 DEGREES TO THE KERB LINE
6. A 127 X 64 X 4 MM R.H.S. HOT DIPPED GALVANISED (OR ALUMINIUM) KERB INSERT WITH AN ADAPTOR FOR 100 MM DIAMETER U.P.V.C. PIPES IS REQUIRED

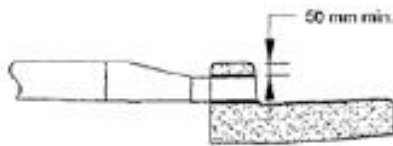

UPVC PIPE/ ADAPTOR AND RHS KERB FITTING

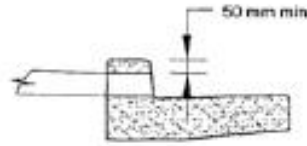

DIRECT RHS CONNECTION

CONNECTIONS OF DRAINAGE LINES TO R.C. PIPES

1. THE R.C STORMWATER PIPE SHALL BE PIERCED BY A NEAT OPENING AS SHOWN TO ALLOW THE CONNECTION OF A SQUARE, SLOPED JUNCTION OR BEND WHICH SHALL NOT PROTRUDE BEYOND THE INNER SURFACE OF THE R.C. STORMWATER PIPE
2. THE INTERNAL JUNCTION SHALL BE SMOOTHLY FINISHED WITH 2:1 CEMENT MORTAR OR EPOXY CEMENT SO AS TO PRESENT NO OBSTRUCTION WITHIN THE INTERNAL SURFACE OF THE R.C. STORMWATER PIPE. THE LINE IS NOT TO EXTEND BEYOND POINT 1 UNTIL APPROVED BY COUNCIL
3. THE HOLE IN COUNCIL'S PIPE IS TO BE FORMED BY CAREFUL DRILLING TO NEATLY ACCEPT THE OUTSIDE DIAMETER OF THE PIPE
4. ANY DAMAGE TO THE STRUCTURE OF COUNCIL'S PIPE IS TO BE MADE GOOD TO THE SATISFACTION OF COUNCIL'S ENGINEER, IF NECESSARY BY THE REPLACEMENT OF THE PIPE.
5. PIPE FITTINGS ARE TO BE VITRIFIED CLAY OR SEWER QUALITY U.P.V.C.
6. COUNCIL PIPELINE IS TO BE LEFT FREE OF DROPPED CLAY, CONCRETE, MORTAR, etc.

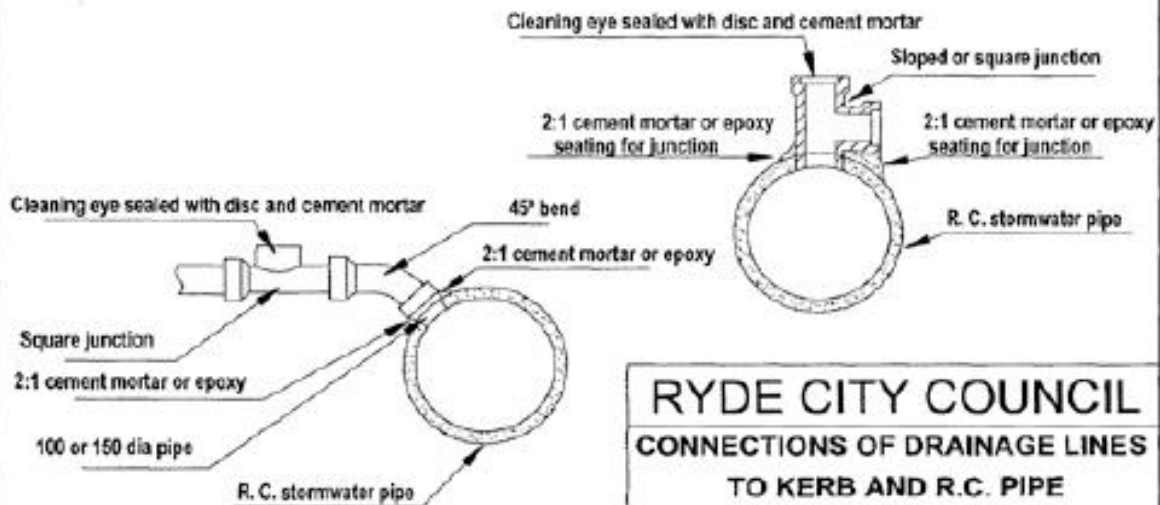

RYDE CITY COUNCIL
CONNECTIONS OF DRAINAGE LINES
TO KERB AND R.C. PIPE

Not to Scale

8.2 Appendix 2 - Absorption System Calculation Sheet

DEVELOPMENT TYPE:

ADDRESS:

Catchment Zone =	(Zone 1)	(Zone 2)	(Eastwood)		
1. Site Area =			_____	m ²	(A)
2. Roof Area =			_____	m ²	(B)
3. Driveway Area =			_____	m ²	(C)
4. Other Paved Area =			_____	m ²	(D)
5. Pervious Paving Area =	m ² x 0.25 =		_____	m ²	(E)
6. Total Proposed Impervious Area (B + C + D+ E) =			_____	m ²	(F)
7. Total Impervious Area Draining to Absorption Trench =			_____	m ²	(G)
(As much of the impervious areas possible are to drain to the absorption system, with 100% of the roof area and driveway area to connect to the system)					
8. Site impervious % = (F)/(A) x 100 =			_____	%	(H)
(must be less than 40%)					
9. If (C) < 35% then go to step 10					

If (C) > 35% then onsite detention is required.

Impervious area over 35% = (((H) -35)/100) x (A) =			_____	m ²	(I)
10. Rainwater Tank Volume to be provided = (I) x (0.2) =			_____	m ³	(J)
11. Area available for dispersal =			_____	m ²	(K)
12. Rainfall Intensity (mm/hr)					
For a 1 in 5 year 20min Storm:	Zone 1 = 88.2				
	Zone 2 and Eastwood = 82.7		_____	mm/hr	(L)
13. Volume of Runoff = (G) x (L) x (1/3) =			_____		(M)
14. Storage Required = (M) /1000 =			_____	m ³	(N)
15. Absorption Trench Type =			_____		
16. Storage Capacity per lineal metre (from product guide) =			_____	m ³ /m	(O)
17. Additional Storage Capacity in Gravel Trench with voids			_____		

= (trench width (m) x trench height (m) – cross section area of absorption trench (m²)) x void space

			_____	m ³ /m	(P)
18. Total Storage Capacity = (O) + (P) =			_____	m ³ /m	(Q)

19. Length of Trench Required = (N)/(Q)

Length = _____	m
----------------	---

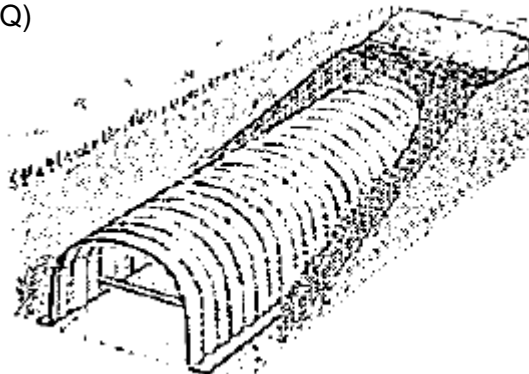

8.3 Appendix 3 – Onsite Detention Calculation Sheet

**RYDE CITY COUNCIL
ON-SITE DETENTION CALCULATION SHEET**

DEVELOPMENT TYPE: _____

ADDRESS: _____

Catchment Zone	(Zone 1)	(Zone 2)	(Eastwood)
Site Area		_____	m ² (A)
65% Site Area		_____	m ²
Total Proposed Impervious Area (roofs, driveways, hardstand etc)		_____	m ² (B)
% of site impervious		_____	%
Impervious area draining to the Storage Facility		_____	m ² (C)
Pervious area draining to the Storage Facility		_____	m ² (D)
Total area draining to the Storage Facility (impervious and pervious areas)		_____	m ² (E)
Pervious area bypassing the Storage Facility		_____	m ² (F)
Impervious area bypassing the Storage Facility		_____	m ² (G)
	$\frac{(C)+(G)}{(C)}$	1. _____	(L)

must not be greater than 1.25.

Permitted Site Discharge (PSD) rate per m²

Catchments in Zones 1 & 2

If (G)=0 then PSD = 0.0265 l/sec/m²

If (G)≠0 then PSD = 0.0265x(L)^{-1.37} l/sec/m²

Eastwood Catchment

If (G)=0 then PSD = 0.0210 l/sec/m²

If (G)≠0 then PSD = 0.0210x(L)^{-1.37} l/sec/m²

_____ (J)

PERMITTED SITE DISCHARGE (E) x (J) _____ x _____

l/s

Storage Volume per m²

(K) = 0.0275 m³/m² for zone 1 or

(K) = 0.0255 m³/m² for zone 2 or

(K) = 0.0300 m³/m² for Eastwood Catchment

_____ (K)

SITE STORAGE REQUIREMENT ((E) + (G)) x (K)x(1.2)^v _____ + _____ x _____ (x1.2)

m³

NOTE ^v If OSD is provided in a landscaped surface basin the volume must be increased by 20%

OUTLET CONTROL - using a Sharp Edged Orifice Plate

Height Difference between top water level and Centre of Orifice (m) _____ (H)

$$\text{mm} = 21.9 \sqrt{\frac{PSD}{\sqrt{(H)}}}$$

ORIFICE DIAMETER (mm)

Should pipe and pit losses be used to control outflow, the calculations are to be attached.

8.4 Appendix 4: DRAINS, RAFTS and XPSTORM Input Parameters

Drains Model			
Parameter	Description	Value	Unit
Model	Rational Method Procedure	ARR 98	
	Soil Type - Normal	3.0	
	Paved (impervious) Area Depression Storage	1	mm
	Supplementary Area Depression Storage	1	mm
	Grassed (Pervious) Area Depression Storage	5	mm
AMC	Antecedent Moisture Condition	2.5	
ku	Pit loss Factor	See xxx	
	Pit Blockage Factor	See xxx	
	Minimum Pit freeboard	150	mm

RAFTS and XP STORM Models			
Parameter	Description	Value	Unit
CAPIMP	Capacity of Impervious Area Storage	1.5	mm
ISC	Interception Storage Capacity	1.5	mm
DSC	Depression Storage Capacity	5	mm
USC	Capacity – Upper Soil Zone Storage	25	mm
LSC	Capacity – Lower Soil Zone Storage	100	mm
UH	Maximum Potential Evapotranspiration from Upper Soil	10	mm/day
LH	Maximum Potential Evapotranspiration from Lower Soil	10	mm/day

ER	Proportion of Evapotranspiration from USC	0.7	
IDS	Initial Impervious Area Storage	0.5	mm
IS	Initial Interception Storage	0.5	mm
DS	Initial Depression Storage (pervious)	0	mm
US	Initial Upper Soil Zone Storage	20	mm
LS	Initial Lower Soil Zone Storage	80	mm
GS	Initial Groundwater Storage	0	mm
GN	Groundwater Recession Factor	1	mm
SO	Sorptivity of Dry Soil	3.0	mm/min-
Ko	Saturated hydraulic Conductivity	0.33	mm/min
LDF	Lower Soil Drainage Factor	0.05	
KG	Constant Rate Groundwater Recession Factor	0.94	
ECOR	Rate of Potential Evaporation from "A" Class Pan	0.70	
IAR	Proportion of Rainfall intercepted by Vegetation	0.7	

8.5 Appendage 5: Ryde Catchment Map

OSD Catchment Map for RCC



Catchment	Permissible Site Discharge (PSD) (l/sec/m ²)	Site Storage Requirement (SSR)(m ³ /m ²)
Zone 1	0.0265	0.0275
Zone 2	0.0265	0.0255
Eastwood	0.0210	0.0300

8.6 Appendix 6: IFD Data

Time	Intensity mm/hr for ARI						
(mins)	Zone 1 (NW): Buffalo, Gladesville, Industrial, Kittys, Lane Cove, Mars, Porters, Shrimptons, Terrys						
	1	2	5	10	20	50	100
5	97.3	123.7	154.5	171.7	194.9	224.9	247.4
6	91.2	116.0	144.9	161.1	182.9	211.1	232.3
7	86.1	109.6	137.0	152.3	173.1	199.9	220.0
8	81.8	104.1	130.3	145.0	164.8	190.4	209.7
9	78.0	99.4	124.5	138.6	157.6	182.2	200.7
10	74.7	95.2	119.4	133.0	151.3	175.0	192.8
11	71.7	91.5	114.8	128.0	145.7	168.6	185.8
12	69.1	88.2	110.7	123.5	140.6	162.8	179.4
13	66.7	85.2	107.0	119.4	136.0	157.5	173.7
14	64.6	82.4	103.7	115.7	131.8	152.7	168.4
15	62.6	79.9	100.6	112.2	127.9	148.3	163.6
16	60.7	77.6	97.7	109.1	124.4	144.2	159.1
17	59.1	75.4	95.1	106.2	121.1	140.4	154.9
18	57.5	73.5	92.6	103.4	118.0	136.9	151.1
19	56.0	71.6	90.3	100.9	115.1	133.6	147.5
20	54.7	69.9	88.2	98.5	112.4	130.5	144.1
21	53.4	68.2	86.1	96.3	109.9	127.6	140.9
22	52.2	66.7	84.2	94.2	107.5	124.8	137.9
23	51.0	65.2	82.4	92.2	105.3	122.3	135.1
24	49.9	63.9	80.7	90.3	103.2	119.8	132.4
25	48.9	62.6	79.1	88.6	101.2	117.5	129.8
26	48.0	61.4	77.6	86.9	99.2	115.3	127.4
27	47.0	60.2	76.2	85.3	97.4	113.2	125.1
28	46.2	59.1	74.8	83.7	95.7	111.2	122.9
29	45.3	58.0	73.5	82.3	94.0	109.3	120.8
30	44.5	57.0	72.2	80.9	92.4	107.5	118.8
31	43.8	56.0	71.0	79.5	90.9	105.7	116.9
32	43.0	55.1	69.8	78.3	89.5	104.1	115.1
33	42.3	54.2	68.7	77.0	88.1	102.5	113.3
34	41.7	53.4	67.7	75.8	86.8	100.9	111.6
35	41.0	52.5	66.7	74.7	85.5	99.5	110.0
36	40.4	51.7	65.7	73.6	84.2	98.0	108.4
37	39.8	51.0	64.7	72.6	83.1	96.7	106.9
38	39.2	50.2	63.8	71.6	81.9	95.3	105.5
39	38.7	49.5	62.9	70.6	80.8	94.1	104.1
40	38.1	48.9	62.1	69.7	79.7	92.8	102.8
41	37.6	48.2	61.3	68.7	78.7	91.7	101.4
42	37.1	47.6	60.5	67.9	77.7	90.5	100.2
43	36.6	46.9	59.7	67.0	76.7	89.4	99.0
44	36.1	46.3	59.0	66.2	75.8	88.3	97.8
45	35.7	45.8	58.2	65.4	74.9	87.3	96.6
50	33.6	43.1	55.0	61.8	70.8	82.5	91.4
55	31.8	40.8	52.1	58.6	67.2	78.4	86.9
60	30.2	38.8	49.6	55.8	64.1	74.8	82.9
70	27.6	35.4	45.4	51.2	58.8	68.7	76.2
80	25.4	32.7	42.0	47.4	54.5	63.8	70.8
90	23.6	30.5	39.2	44.3	51.0	59.7	66.4
100	22.1	28.5	36.8	41.6	48.0	56.3	62.6
110	20.9	26.9	34.8	39.4	45.4	53.3	59.3
120	19.7	25.5	33.0	37.4	43.2	50.7	56.5
150	17.1	22.1	28.8	32.8	37.9	44.6	49.8
180	15.2	19.7	25.8	29.4	34.0	40.2	44.9

North East Polynomial Coefficient:

3.4086	-.58988	-.040977	.006755	0.0018839	-6.9872E-05	-7.6289E-05
3.6589	-.58398	-.039062	.0069866	0.0015993	-1.1613E-04	-6.0789E-05
3.9042	-.56826	-.033879	.0076074	8.3204E-04	-2.3972E-04	-1.9187E-05
4.0221	-.56005	-.031169	.0079322	4.3088E-04	-3.0432E-04	2.5585E-06
4.1597	-.55326	-.028933	.0082005	0.0000998	-3.5774E-04	2.052E-05
4.3146	-.54563	-.026414	.0085028	-0.0002732	-4.1779E-04	4.074E-05
4.4178	-.54054	-.024736	.0087022	-5.2147E-04	-4.5768E-04	5.4188E-05

Time (mins)	Intensity mm/hr for ARI Zone 2 (South-West Zone) : Archer, Charity, Denistone, Eastwood, River						
	1	2	5	10	20	50	100
5	91.1	116.2	146.2	163.1	185.9	215.4	237.55
6	85.3	108.9	137.1	153.1	174.5	202.3	223.18
7	80.5	102.8	129.6	144.7	165.0	191.4	211.21
8	76.4	97.6	123.1	137.6	157.0	182.1	200.99
9	72.9	93.2	117.6	131.4	149.9	174.0	192.10
10	69.8	89.2	112.7	125.9	143.8	166.8	184.25
11	67.0	85.7	108.3	121.1	138.2	160.5	177.26
12	64.6	82.6	104.4	116.7	133.3	154.8	170.96
13	62.3	79.7	100.8	112.8	128.8	149.6	165.25
14	60.3	77.2	97.6	109.2	124.7	144.8	160.04
15	58.4	74.8	94.6	105.9	120.9	140.5	155.26
16	56.7	72.6	91.9	102.8	117.5	136.5	150.85
17	55.1	70.6	89.3	100.0	114.3	132.8	146.77
18	53.7	68.7	87.0	97.4	111.3	129.3	142.97
19	52.3	66.9	84.8	94.9	108.5	126.1	139.43
20	51.0	65.3	82.7	92.6	105.9	123.1	136.12
21	49.8	63.8	80.8	90.5	103.5	120.3	133.01
22	48.7	62.3	79.0	88.5	101.2	117.6	130.09
23	47.6	60.9	77.3	86.6	99.0	115.1	127.33
24	46.6	59.7	75.7	84.8	97.0	112.8	124.73
25	45.6	58.4	74.1	83.1	95.0	110.5	122.26
26	44.7	57.3	72.7	81.5	93.2	108.4	119.92
27	43.9	56.2	71.3	79.9	91.4	106.4	117.70
28	43.0	55.1	70.0	78.5	89.8	104.5	115.58
29	42.2	54.1	68.7	77.1	88.2	102.6	113.56
30	41.5	53.2	67.5	75.7	86.7	100.9	111.63
31	40.8	52.3	66.4	74.5	85.2	99.2	109.79
32	40.1	51.4	65.3	73.3	83.8	97.6	108.03
33	39.4	50.6	64.3	72.1	82.5	96.1	106.34
34	38.8	49.8	63.3	71.0	81.2	94.6	104.72
35	38.2	49.0	62.3	69.9	80.0	93.2	103.17
36	37.6	48.3	61.4	68.9	78.9	91.8	101.67
37	37.1	47.5	60.5	67.9	77.7	90.5	100.23
38	36.5	46.9	59.6	66.9	76.6	89.3	98.85
39	36.0	46.2	58.8	66.0	75.6	88.1	97.51
40	35.5	45.6	58.0	65.1	74.6	86.9	96.22
41	35.0	44.9	57.2	64.2	73.6	85.8	94.98
42	34.6	44.3	56.5	63.4	72.7	84.7	93.77
43	34.1	43.8	55.7	62.6	71.7	83.6	92.61
44	33.7	43.2	55.1	61.8	70.9	82.6	91.49
45	33.3	42.7	54.4	61.1	70.0	81.6	90.40
50	31.3	40.2	51.3	57.6	66.1	77.1	85.43
55	29.7	38.1	48.6	54.7	62.7	73.2	81.12
60	28.2	36.2	46.3	52.1	59.8	69.8	77.35
70	25.8	33.2	42.4	47.8	55.0	64.0	71
80	23.8	30.6	39.2	44.2	51.0	59.0	66
90	22.1	28.5	36.6	41.3	47.5	56.0	62
100	20.8	26.7	34.4	38.8	44.7	52.0	58
110	19.6	25.2	32.5	26.7	42.3	49.6	55
120	18.6	23.9	30.9	34.9	40.2	47.2	52
150	16.1	20.8	27.0	30.6	35.3	41.5	46.2
180	14.4	18.6	24.2	27.4	31.7	37.3	41.6

South West Polynomial Coefficient:

3.3393	-.58392	-.033169	.0077673	7.1372E-04	-.0002336	1.7908E-05
3.5896	-.57971	-.031933	.0077639	5.8990E-04	-2.3827E-04	1.3537E-05
3.8349	-.56852	-.02862	.0077548	2.5919E-04	-2.5059E-04	-1.8835E-06
3.9527	-.56266	-.026887	.0077487	8.6322E-05	-2.5681E-04	4.1675E-06
4.0903	-.55783	-.025456	.0077458	-5.6644E-05	-2.6224E-04	9.2213E-06
4.2452	-.5524	-.023848	.0077412	-2.1702E-04	-2.6821E-04	1.4868E-05
4.3484	-.54877	-.022773	.0077379	-3.2437E-04	-2.7212E-04	1.8636E-05

8.7 Appendix 7 – Discharge – Velocity Graph

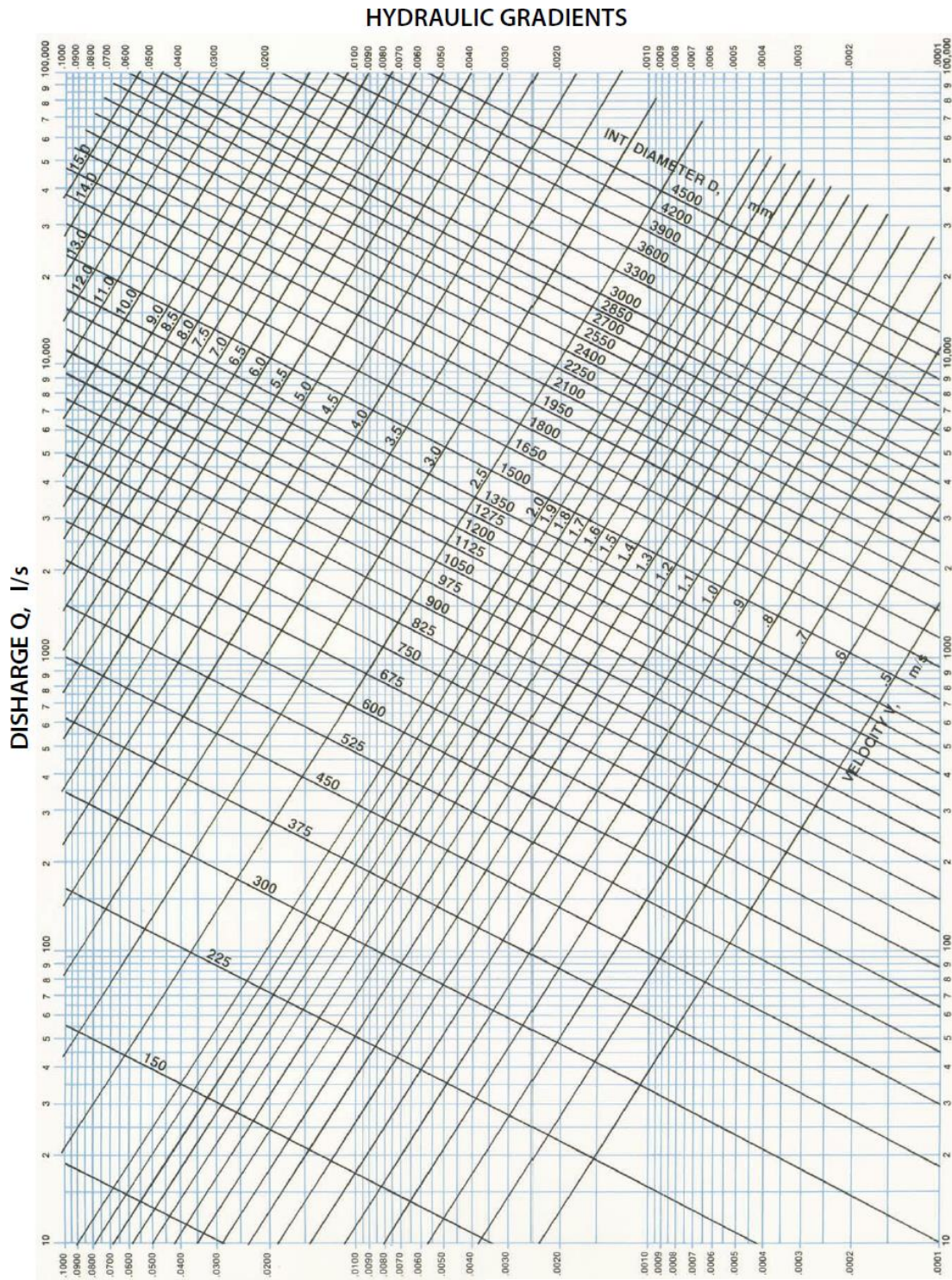

Discharge and velocity graph

Colebrook-White formula $k = 0.60\text{mm}$

For circular pipes running full but not under head.

Computed by: $\frac{1}{\sqrt{f}} = -2\log_{10} \left(\frac{k}{3.7D} + \frac{k}{R_c \sqrt{f}} \right)$

8.8 Appendix 8 - Pit Inlet Design Figure: Grated Kerb Inlet – Independent of grade

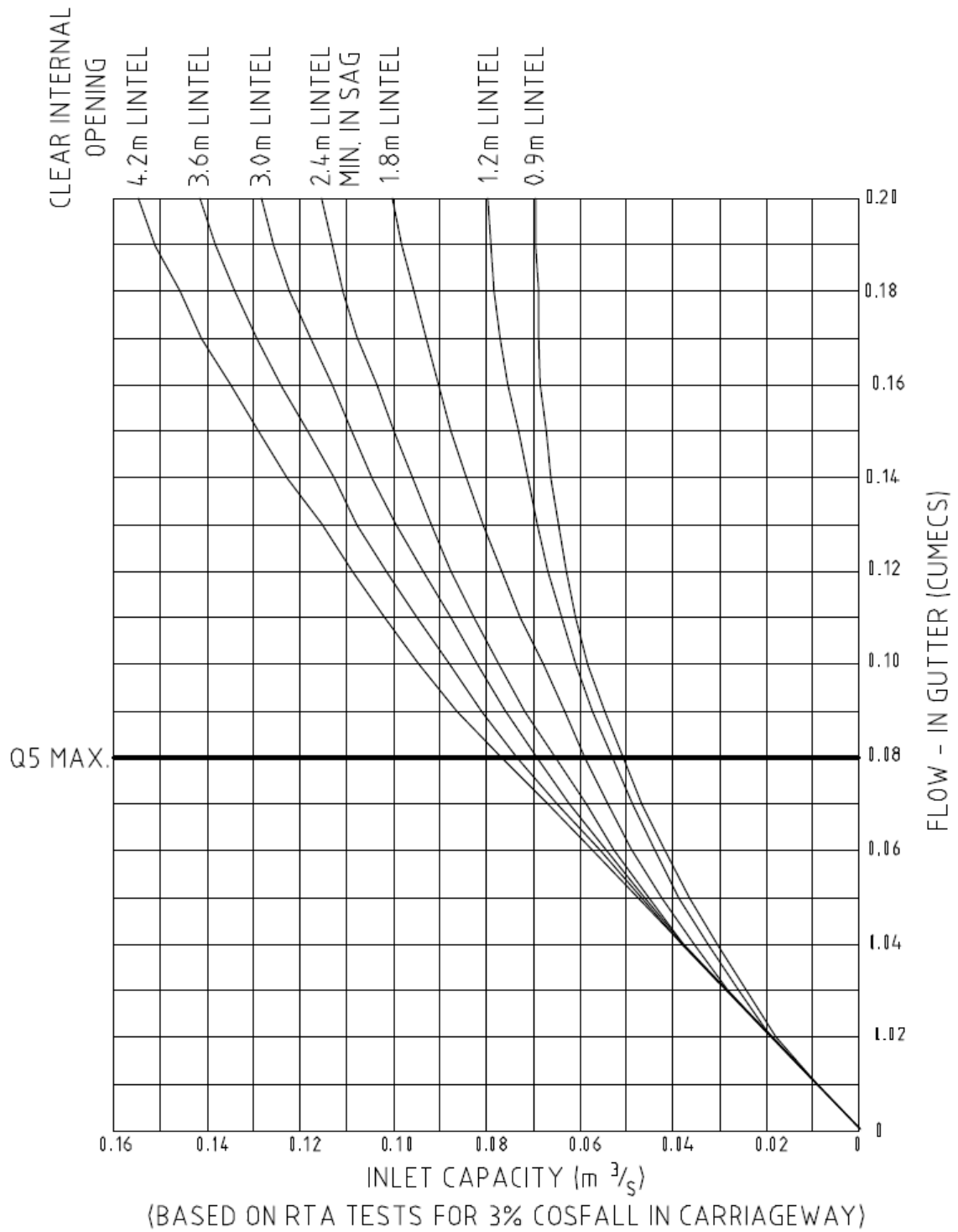

8.9 Appendix 9 - Pit Inlet Design Figure: Kerb Inlets in Sags

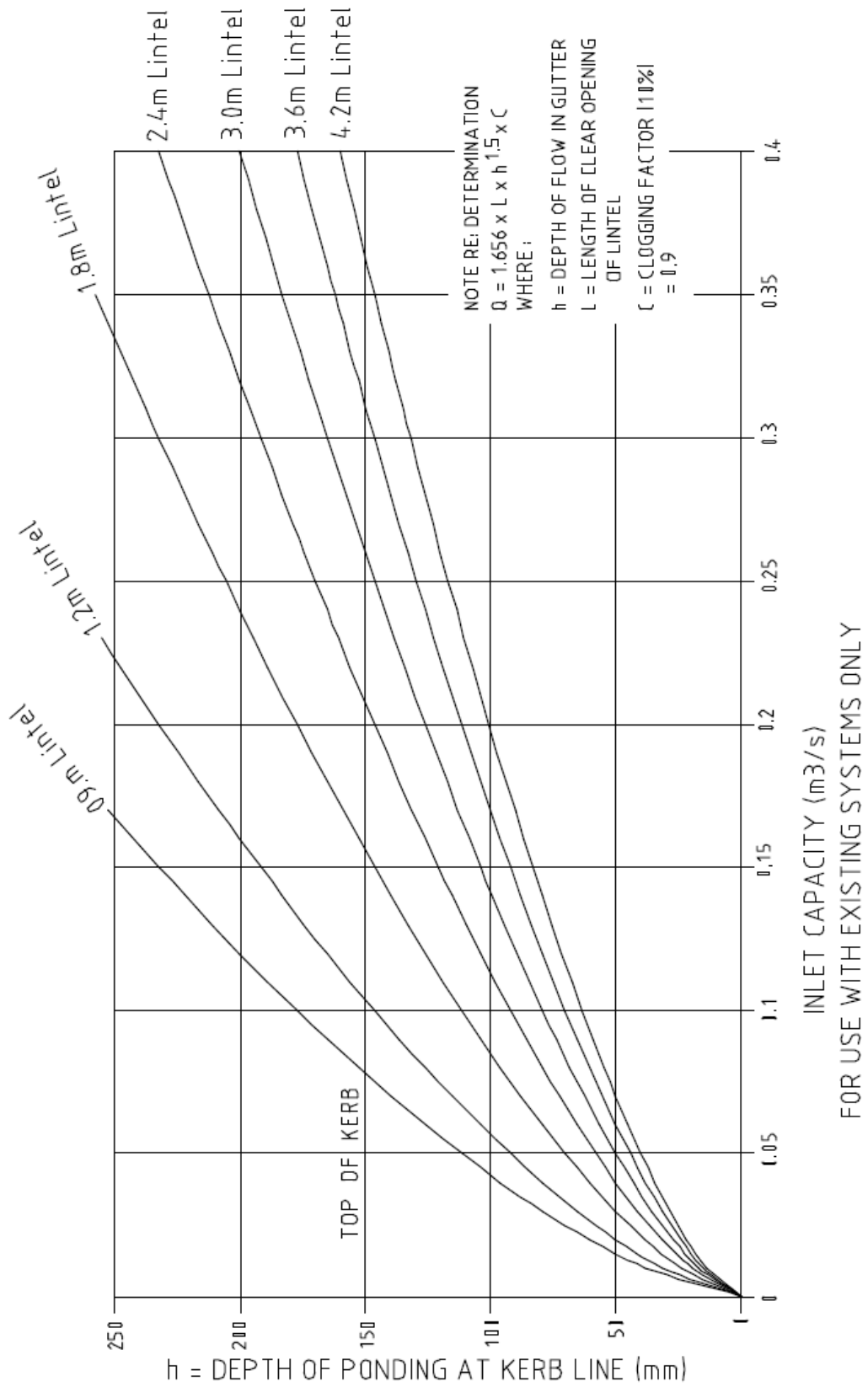

8.10 Appendix 10 - Pit Inlet Design Figure: Inlets Capacities for Gratings in Sags

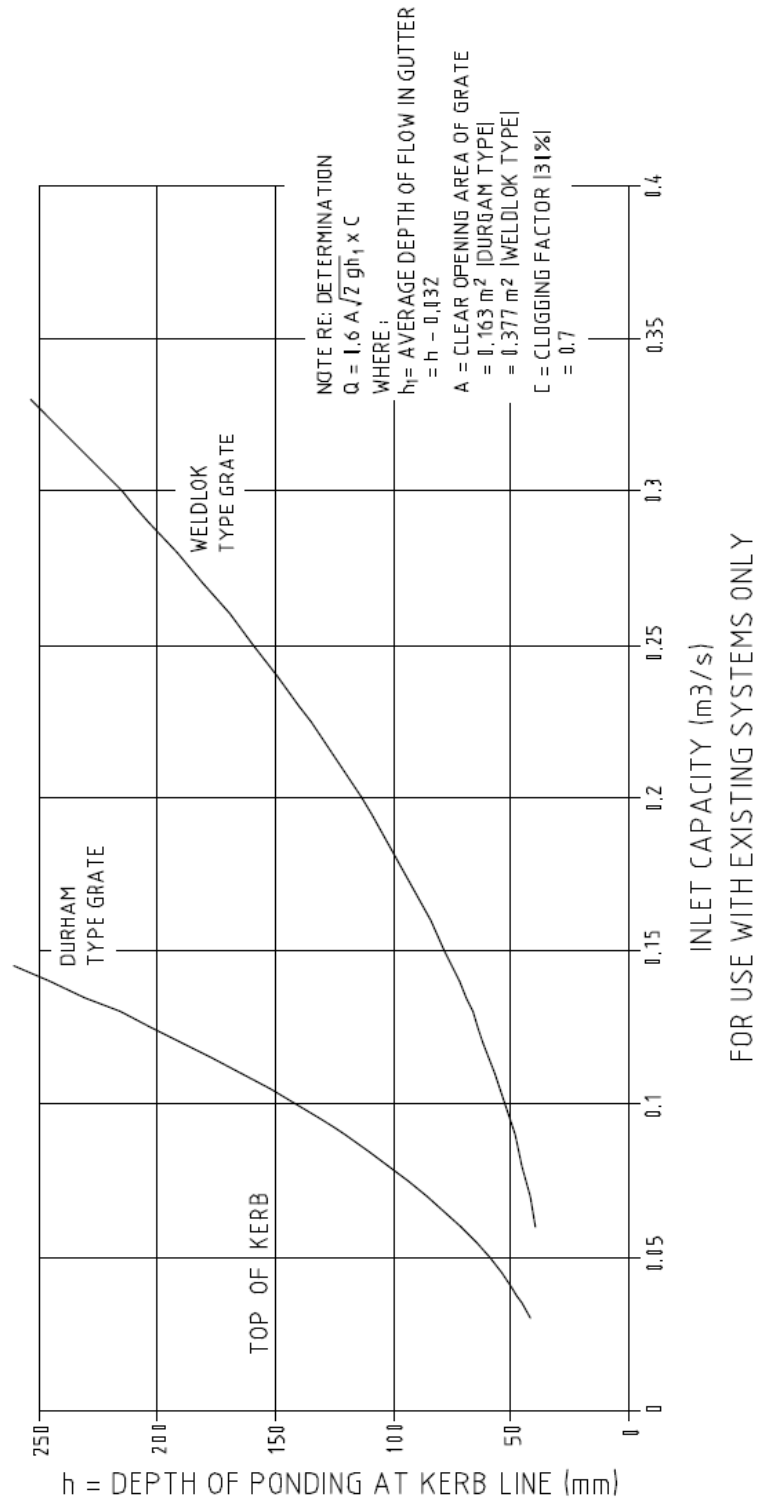

8.11 Appendix 11 - Pit Inlet Design Figure: Inlets Capacities for Kerb Inlets with Duram Type Grates in Sags

NOTE: This chart is based on the equations shown on Appendix 9 and 10.

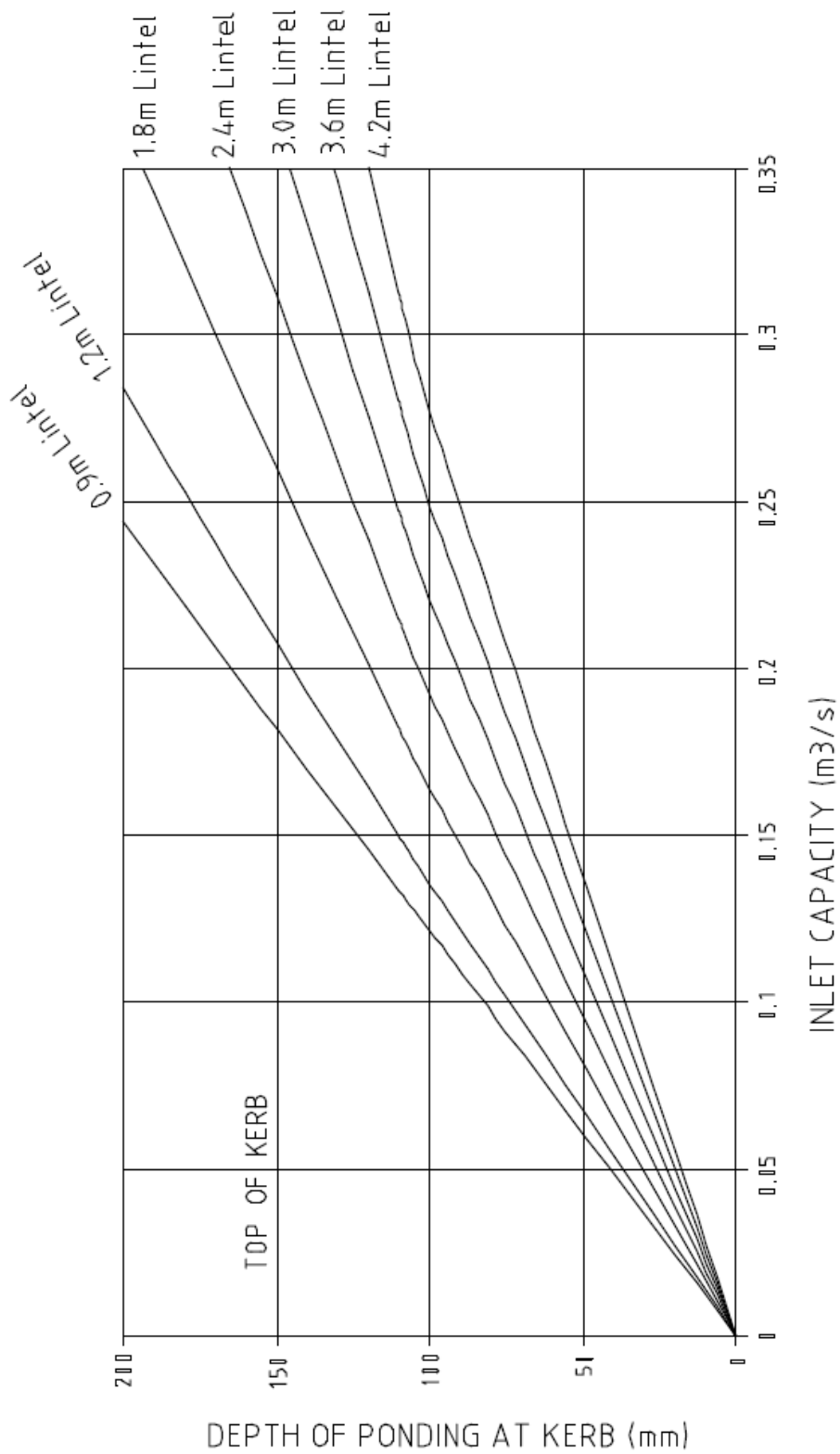

8.12 Appendix 12 - Pit Inlet Design Figure: Inlets Capacities for Kerb Inlets with WELDLOC Type Grates in Sags

NOTE: This chart is based on the equations shown on Appendix 9 and 10.

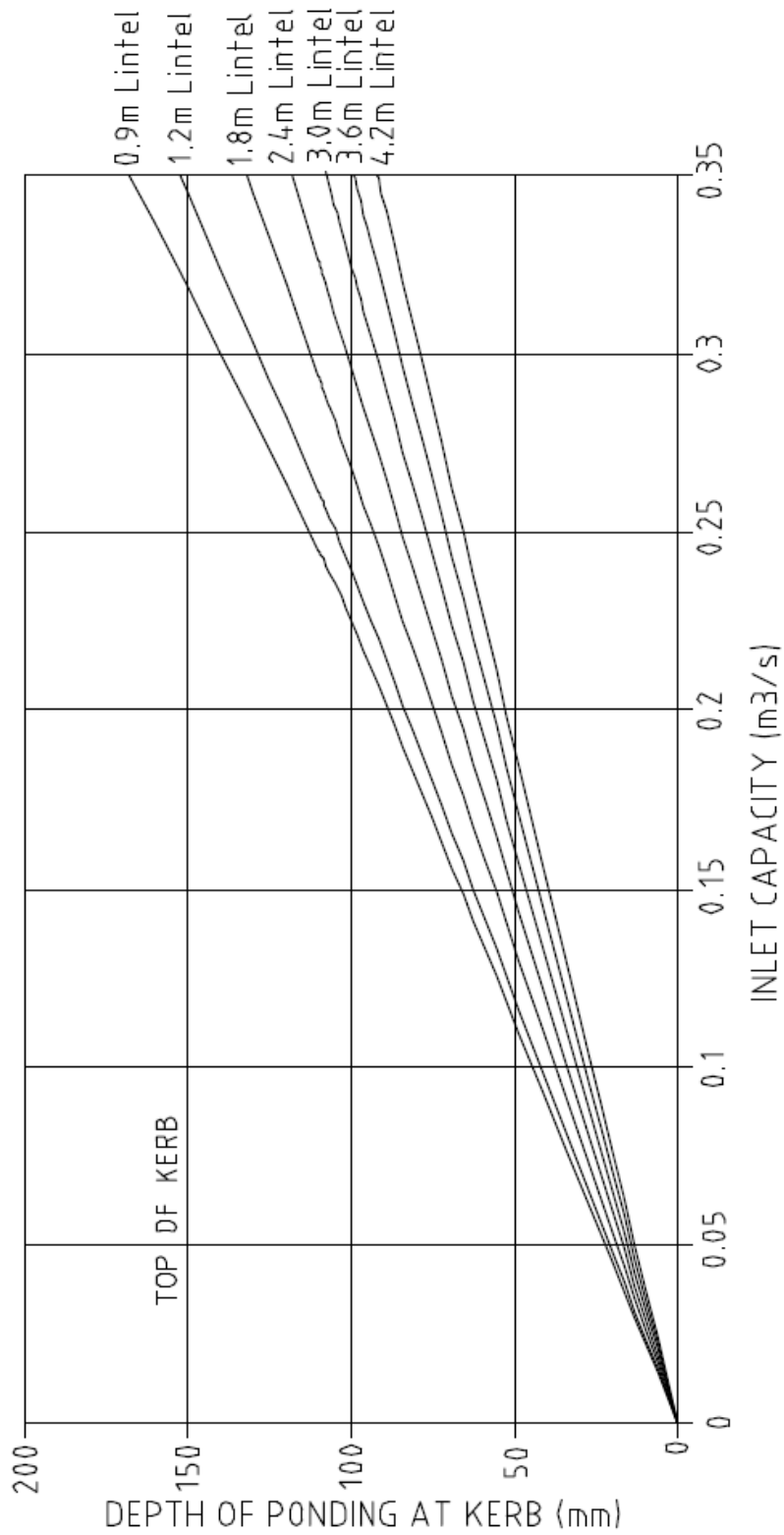

8.13 Appendix 13: Orifice sized according to depth of ponding and PSD.

PSD l/s	Depth of tank above centreline of orifice																				
	0.1	0.2	0.3	0.4	0.5	0.6	0.7	0.8	0.9	1.0	1.1	1.2	1.3	1.4	1.5	1.6	1.7	1.8	1.9	2.0	
2	55	46	42	39	37	35	34	33	32	31	30	30	29	28	28	28	27	27	26	26	Min. 100 mm diameter outlet pipe
3	67	57	51	48	45	43	41	40	39	38	37	36	36	35	34	34	33	33	32	32	
4	78	65	59	55	52	50	48	46	45	44	43	42	41	40	40	39	38	38	37	37	
5	87	73	66	62	58	56	54	52	50	49	48	47	46	45	44	44	43	42	42	41	
6	95	80	72	67	64	61	59	57	55	54	52	51	50	49	48	48	47	46	46	45	
7	103	87	78	73	69	66	63	61	59	58	57	55	54	53	52	51	51	50	49	49	Min. 150 mm diameter outlet pipe
8	110	93	84	78	74	70	68	65	64	62	60	59	58	57	56	55	54	53	53	52	
9	117	98	89	83	78	75	72	69	67	66	64	63	61	60	59	58	58	57	56	55	
10	123	104	94	87	82	79	76	73	71	69	68	66	65	64	63	62	61	60	59	58	
11	129	109	98	91	86	82	79	77	75	73	71	69	68	67	66	65	64	63	62	61	
12	135	113	102	95	90	86	83	80	78	76	74	72	71	70	69	67	66	65	65	64	Min. 225 mm diameter outlet pipe
13	140	118	107	99	94	90	86	83	81	79	77	75	74	73	71	70	69	68	67	66	
14	146	122	111	103	97	93	90	87	84	82	80	78	77	75	74	73	72	71	70	69	
15	151	127	115	107	101	96	93	90	87	85	83	81	79	78	77	75	74	73	72	71	
16	156	131	118	110	104	99	96	93	90	88	85	84	82	80	79	78	77	76	75	74	
17	160	135	122	113	107	103	99	95	93	90	88	86	85	83	82	80	79	78	77	76	Min. 375 mm diameter outlet pipe
18	165	139	125	117	110	106	102	98	95	93	91	89	87	85	84	83	81	80	79	78	
19	170	143	129	120	113	108	104	101	98	95	93	91	89	88	86	85	84	82	81	80	
20	174	146	132	123	116	111	107	104	100	98	96	94	92	90	88	87	86	85	83	82	
21	178	150	136	126	119	114	110	106	103	100	98	96	94	92	91	89	88	87	85	84	
22	183	154	139	129	122	117	112	109	105	103	100	98	96	94	93	91	90	89	87	86	Min. 300 mm diameter outlet pipe
23	187	157	142	132	125	119	115	111	108	105	102	100	98	97	95	93	92	91	89	88	
24	191	160	145	135	128	122	117	113	110	107	105	102	100	99	97	95	94	93	91	90	
25	195	164	148	138	130	124	120	116	112	109	107	105	102	101	99	97	96	94	93	92	
26	198	167	151	140	133	127	122	118	115	112	109	107	105	103	101	99	98	96	95	94	
27		170	154	143	135	129	124	120	117	114	111	109	107	105	103	101	100	98	97	96	Min. 300 mm diameter outlet pipe
28		173	156	146	138	132	127	122	119	116	113	111	108	106	105	103	101	100	99	97	
29		176	159	148	140	134	129	125	121	118	115	113	110	108	107	105	103	102	100	99	
30		179	162	151	143	136	131	127	123	120	117	115	112	110	108	107	105	104	102	101	
31		182	165	153	145	138	133	129	125	122	119	116	114	112	110	108	107	105	104	102	
32		185	167	156	147	141	135	131	127	124	121	118	116	114	112	110	108	107	105	104	Min. 300 mm diameter outlet pipe
33		188	170	158	150	143	137	133	129	126	123	120	118	116	114	112	110	109	107	106	
34		191	172	160	152	145	140	135	131	128	125	122	120	117	115	113	112	110	109	107	
35		194	175	163	154	147	142	137	133	129	126	124	121	119	117	115	113	112	110	109	
36		196	177	165	156	149	144	139	135	131	128	125	123	121	119	117	115	113	112	110	
37		199	180	167	158	151	146	141	137	133	130	127	125	122	120	118	117	115	113	112	Min. 300 mm diameter outlet pipe
38		202	182	170	160	153	148	143	139	135	132	129	126	124	122	120	118	116	115	113	
39		204	185	172	163	155	149	145	140	137	133	131	128	126	124	122	120	118	116	115	
40		207	187	174	165	157	151	146	142	138	135	132	130	127	125	123	121	120	118	116	
41		210	189	176	167	159	153	148	144	140	137	134	131	129	127	125	123	121	119	118	
42		212	192	178	169	161	155	150	146	142	139	136	133	130	128	126	124	122	121	119	Min. 300 mm diameter outlet pipe
43		215	194	180	171	163	157	152	147	144	140	137	134	132	130	128	126	124	122	121	
44		217	196	183	173	165	159	154	149	145	142	139	136	133	131	129	127	125	124	122	
45		220	198	185	175	167	161	155	151	147	143	140	138	135	133	131	129	127	125	123	
46		222	201	187	177	169	162	157	152	148	145	142	139	136	134	132	130	128	126	125	
47		224	203	189	178	170	164	159	154	150	147	143	141	138	136	133	131	130	128	126	Min. 300 mm diameter outlet pipe
48		227	205	191	180	172	166	160	156	152	148	145	142	139	137	135	133	131	129	128	
49		229	207	193	182	174	168	162	157	153	150	146	143	141	138	136	134	132	131	129	
50		231	209	195	184	176	169	164	159	155	151	148	145	142	140	138	136	134	132	130	

The values calculated above are for a circular, square cut edge orifice only.

8.14 Appendix 14: Example Easement Letter

Dear

I/we

are proposing to redevelop our property at

Before we can proceed with this proposal Council has advised us that we have two options for the drainage of stormwater, the first, which is Council's preferred method, is to obtain a drainage easement to convey the stormwater runoff from our property to the nearest public stormwater drainage infrastructure or Council approved discharge point, being

This will require you to grant me/us a drainage easement through your property with all legal and survey costs for the creation of the easement being borne by us, together with any consideration for the use of your property as determined by an independent valuation or agreement. (Attach independent valuation or agreement to this form).

The other alternative is to install an underground absorption system or level spreader (if appropriate for this site) to spread and disperse the stormwater flow. As the runoff and seepage from this system may flow towards your property because of the slope of the land, the best solution would be to have a drainage system that will convey our stormwater via an interallotment drainage pipe to

You are advised that if Council determines that the only way for the drainage of stormwater is via an easement through your property, I/we may have to use Section 88K of the Conveyancing Act 1919 to request the Supreme Court to grant me/us the drainage easement. This will probably result in legal expenses and time spent for both you and I/us.

Could you please indicate your position regarding this matter so that we can advise Council to enable our application to progress.

YES I/we are willing to grant you a drainage easement.

.....

Name Address

NO I/we are not willing to grant you a drainage easement.

.....

Name Address